



DOE Microreactor Program: Summary of Experimental Capabilities Development and Activities

June 2021

Changing the World's Energy Future

Piyush Sabharwall (INL), Holly Trellue (LANL), Jeremy Hartvigsen (INL), Terry Morton (INL), Donna Guillen (INL), Yasir Arafat (INL), Theresa Cutler (LANL), Keith Jewell (INL), Erik Luther (LANL), Robert Reid (LANL), Chase Taylor (INL), Troy Unruh (INL), Chris Petrie (ORNL), David Mascarenas (LANL), Peter Meyerhoffer (LANL), James Jewell (INL), Jess Gehin (INL), and John Jackson (INL)



DISCLAIMER

This information was prepared as an account of work sponsored by an agency of the U.S. Government. Neither the U.S. Government nor any agency thereof, nor any of their employees, makes any warranty, expressed or implied, or assumes any legal liability or responsibility for the accuracy, completeness, or usefulness, of any information, apparatus, product, or process disclosed, or represents that its use would not infringe privately owned rights. References herein to any specific commercial product, process, or service by trade name, trademark, manufacturer, or otherwise, does not necessarily constitute or imply its endorsement, recommendation, or favoring by the U.S. Government or any agency thereof. The views and opinions of authors expressed herein do not necessarily state or reflect those of the U.S. Government or any agency thereof.

DOE Microreactor Program: Summary of Experimental Capabilities Development and Activities

**Piyush Sabharwall (INL), Holly Trelue (LANL), Jeremy Hartvigsen (INL),
Terry Morton (INL), Donna Guillen (INL), Yasir Arafat (INL),
Theresa Cutler (LANL), Keith Jewell (INL), Erik Luther (LANL),
Robert Reid (LANL), Chase Taylor (INL), Troy Unruh (INL), Chris Petrie (ORNL),
David Mascarenas (LANL), Peter Meyerhoffer (LANL), James Jewell (INL),
Jess Gehin (INL), and John Jackson (INL)**

June 2021

**Idaho National Laboratory
Originating Organization NS&T
Idaho Falls, Idaho 83415**

<http://www.inl.gov>

**Prepared for the
U.S. Department of Energy
Office of Nuclear Energy
Under DOE Idaho Operations Office
Contract DE-AC07-05ID14517**

Page intentionally left blank

ABSTRACT

This document provides a summary of the experimental capabilities and activities developed and currently performed under the U.S. Department of Energy's (DOE's) Microreactor Program. These capabilities, along with other laboratory capabilities, are available to support developer and other stakeholder needs. Specific experimental capabilities described in this document include the single primary heat extraction and removal emulator (SPHERE), the microreactor agile non-nuclear experimental test bed (MAGNET), microreactor applications research validation and evaluation (MARVEL), yttrium hydride fabrication, the Hypatia critical experiment series, and a brief overview of the National Criticality Experiments Research Center (NCERC), which provides the platform to conduct experiments and training with critical assemblies and fissionable material.

Page intentionally left blank

CONTENTS

1.	INTRODUCTION.....	1
2.	THERMAL AND HEAT-TRANSFER TESTING.....	1
2.1	Single Primary Heat Extraction and Removal Emulator	1
2.2	Microreactor Agile Non-Nuclear Experimental Test Bed	4
2.3	Advanced Heat-Removal Systems	10
2.4	Test Articles and Instrumentation	11
2.5	Planned Tests	17
3.	HYDRIDE MODERATOR FABRICATION AND TESTING	20
3.1	Irradiation and Post-Irradiation Examination.....	22
4.	NEUTRONICS TESTING.....	25
5.	MARVEL AND APPLICATIONS INTEGRATION TESTING	28
5.1	Planned Capabilities.....	29
6.	MICROREACTOR PROGRAM SUPPORTED EXPERIMENT CAPABILITIES AT UNIVERSITIES.....	30
6.1	Demonstrating Reactor Autonomous Control Framework Using Graphite Exponential Pile.....	30
6.2	Determining the Effects of Neutron Irradiation on the Structural Integrity of Additively Manufactured Heat Exchangers for Very Small Modular Reactor Applications	31
6.3	Experiments for Modeling and Validation of Liquid-Metal Heat Pipe Simulation Tools for Microreactors.....	31
6.4	Experiments and Computations to Address the Safety Case of Heat-Pipe Failures in Special Purpose Reactors	31
7.	CONCLUSIONS.....	32
8.	REFERENCES.....	32

FIGURES

Figure 1. Process flow diagram for the single heat-pipe experiment.	2
Figure 2. SPHERE test bed and seven-hole test article.	3
Figure 3. Cross-section geometry of a seven-hole core block for the single heat-pipe experiment (e.g., 6 in., 1/2 m, 1 m), not to scale.	4
Figure 4. DETAIL overview.....	5
Figure 5. (a) MAGNET process flow diagram and (b) environmental enclosure.	6
Figure 6. The heat exchanger removes heat from the test article and supplies it to the PCU (Guillen 2020).....	8
Figure 7. Modified Capstone C30 unit in shipping crate.....	9
Figure 8. Layout of PCU loop connected to MAGNET loop by the heat source heat exchanger.	9
Figure 9. Pictures of a stainless steel mini hex block during sensor embedding show: (a) the part in its fixture; (b) UAM layering; (c) completion of the UAM layering process; (d) post-embedding machining; and (e,f) the finished part.....	12
Figure 10. (a) Example of a speckle pattern synthetically generated using Gorjup (2021). (b) Imager used for DIC.	13
Figure 11. Thermowell (0.125 in. ID) in sodium-filled heat-pipe (0.625 in. OD).	14
Figure 12. Ten-point Type K TC in SPHERE (left) and results (right).....	14
Figure 13. Fabricated Type-II FBG.	15
Figure 14. UT transducer housing and connections.....	15
Figure 15. Mockup heat-pipe with fiber-optic wire wrap in test block.	16
Figure 16. Cross-section geometry of the 91-hole (54 heater rods and 37 heat pipes) 75 kW core block.....	17
Figure 17. Equipment needed for establishing a large-scale yttrium hydride capability (left to right): inert-atmosphere glovebox, automated mill, and automated press.....	20
Figure 18. New glovebox at LANL.	21
Figure 19. Sieverts apparatus.....	21
Figure 20. Details of ATR irradiation experiment.....	23
Figure 21. (top) Yttrium hydride samples fabricated for ATR irradiation experiment. (bottom) Tantalum-zirconium-molybdenum alloy (TZM) cans to contain YH.	24
Figure 22. Description of PIE planned for the various YH samples.	24
Figure 23. Yttrium hydride samples for the Hypatia Experiment.	26
Figure 24. Hypatia column pictures and diagrams: (a) Configuration 1 picture; (b) Configuration 1 diagram; (c) fuel column with guide tube and heater and	

resistance-temperature-detector wires in place; (d) Configuration 3 picture; and (e) Configuration 2 diagram.....	26
Figure 25. Full Hypatia Experiment setup on the Planet critical assembly machine at NCERC.....	27
Figure 26. Hypatia Configuration 1 temperature and neutron power profile as a function of run time.....	27
Figure 27. Hypatia Configuration 21 temperature and neutron power profile as a function of run time.....	28
Figure 28. MARVEL reactor at INL’s TREAT Facility.....	29
Figure 29. Overview of project progress. (A) Final 3D computer-aided drawing of the pulley assembly used to precisely control in-pile detectors and the movement of control rods. (B) Simplified schematic of plans for the in-pile facility. (C) Actual picture of the 3D-printed assembly. (D) Picture of pulley assembly installed within the graphite pile. (E) Screen shot of control system graphical user interface that has multiple neural nets embedded in the backend.....	30

TABLES

Table 1. Planned and proposed non-nuclear tests to support accelerated demonstration.....	19
Table 2. PIE measurements that will be performed on YH samples.....	22

ACRONYMS

ACT	Advanced Cooling Technologies, Inc.
ATR	Advanced Test Reactor
BCTC	Bonneville County Technology Center
DETAIL	Dynamic Energy Transport and Integration Laboratory
DIC	Digital Image Correlation
DOE	U.S. Department of Energy
FBG	Fiber Bragg Grating
HTIR-TC	High-Temperature Irradiation-Resistant Thermocouple
ID	Inner Diameter
INL	Idaho National Laboratory
LANL	Los Alamos National Laboratory
MAGNET	Microreactor Agile Non-nuclear Experimental Test Bed
MARVEL	Microreactor Applications Research Validation and Evaluation
MFC	Materials and Fuels Complex
MIT	Massachusetts Institute of Technology
NCERC	National Criticality Experiments Research Center
NRC	U.S. Nuclear Regulatory Commission
OD	Outer Diameter
ORNL	Oak Ridge National Laboratory
PCU	Power Conversion Unit
PIE	Post-Irradiation Examination
R&D	Research and Development
SCR	Silicon Controlled Rectifier
SPHERE	Single Primary Heat Extraction and Removal Emulator
TAMU	Texas A&M University
TEDS	Thermal Energy Distribution System
TC	Thermocouple
TEG	Thermoelectric Generator
TREAT	Transient Reactor Test Facility
UAM	Ultrasonic Additive Manufacturing
U.S.	United States
UT	Ultrasonic Thermometer
UWM	University of Wisconsin-Madison
vSMR	Very Small Modular Reactor

DOE Microreactor Program: Summary of Experimental Capabilities Development and Activities

1. INTRODUCTION

Microreactors of many different types are being considered in the United States (U.S.) under three main categories: gas-cooled, molten-salt-cooled, and heat-pipe-cooled. These reactors operate in different thermal regimes; therefore, they allow for flexibility—a specific reactor for each use case. Amid ongoing efforts to ensure accelerated deployment, the U.S. Department of Energy’s (DOE’s) Microreactor Program works closely with vendors, the U.S. Nuclear Regulatory Commission (NRC), and other U.S. DOE programs to develop the capability to demonstrate concept feasibility through non-nuclear testing and, once proven, assist with nuclear testing using a nuclear test bed. Performing this testing will allow an evaluation of technical and system readiness levels for specific reactor concepts. Those readiness-level evaluations can subsequently be used in conjunction with an expanded decision framework to define a path toward first-of-a-kind deployment. To support the development of microreactor technology, Idaho National Laboratory (INL) is establishing an electrically heated microreactor test bed to enable the experimental evaluation of a variety of microreactor concepts. The primary experimental hardware capabilities currently under development are focused on non-nuclear thermal and integrated systems testing, advanced moderator development, and test article development to enable experiments. Specifically, this includes the Single Primary Heat Extraction and Removal Emulator (SPHERE), the Microreactor Agile Non-nuclear Experimental Test bed (MAGNET), and yttrium hydride fabrication and testing. The SPHERE facility allows for detailed testing that simulates startup and transients, enables better understanding of heat-pipe operations, evaluates performance, and supports verification and validation in direct support of microreactors. The MAGNET facility, in addition to analyzing a heat-pipe microreactor design, will further increase understanding of the potential effects of cascading failure caused by the loss of one heat-pipe in a core. This knowledge is vital, along with understanding the corresponding thermal stresses and heat transfer. Apart from the non-nuclear test bed, a Microreactor Applications Research Validation and Evaluation (MARVEL) nuclear test bed is currently being designed and developed; it should be operational in a few years.

This document summarizes the experimental capabilities and experimental work that is planned and currently performed under DOE’s Microreactor Program. The summary is shared to provide information on work being done by the program that is of specific interest for microreactor research and development (R&D). Substantial experimental capabilities are available through other programs and organizations that can also support microreactor R&D, but this report will primarily focus on current and new capabilities developed by this program. This document will be updated to include additional capabilities as they are planned and developed.

2. THERMAL AND HEAT TRANSFER TESTING

The capabilities described in this report can be made available to researchers and developers for a range of testing purposes. Those needing access to these or requiring other experimental capabilities and data are encouraged to reach out to the Microreactor Program national technical director. Full contact information is available on the program website at: <https://gain.inl.gov/SitePages/MicroreactorProgram.aspx>.

2.1 Single Primary Heat Extraction and Removal Emulator

The purpose of the SPHERE facility is to provide experimental and operational heat-pipe data for reactors cooled by this method. A process flow diagram for the SPHERE facility is shown in **Error! Reference source not found.** Cooling water is recirculated using a 2.5 kW circulating chiller unit. The water flow loop includes a precision turbine flowmeter and a delta-T meter that will allow for accurate determination of the heat removal rate from the heat-pipe to the cooling water. Prior to testing, a quartz tube

may be evacuated using a vacuum pump and then backfilled with inert gas (He or Ar). This process (i.e., successive dilution) is repeated several times at the beginning of each test to ensure that all of the air has been removed.

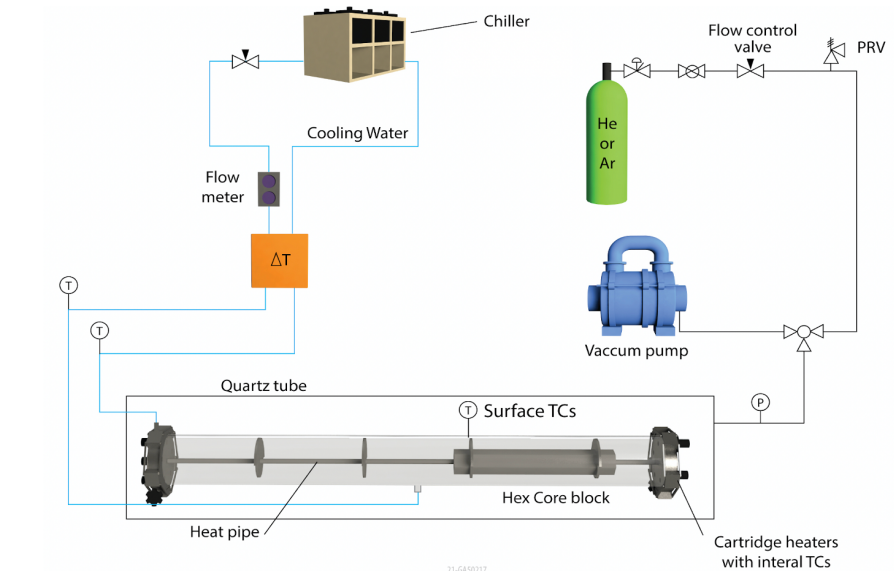

Figure 1. Process flow diagram for the single heat-pipe experiment.

The SPHERE test bed, as shown in Figure 2, is located in the Bonneville County Technology Center (BCTC) facility at INL. The characteristics of the test bed are provided in the lists that follow. Test chamber characteristics include:

- Vacuum (10^{-4} torr) or inert gas
- 8-ft long \times 6-in. diameter quartz tube
- Flanges for gas-flow connections and instrumentation feedthrough ports.

Electrical heating capability requires:

- A test bed designed for up to 20 kW electrical power to heaters
- Maximum test article temperature of 750°C
- Heat rejection through passive radiation or coupled with a water-cooled gas-gap calorimeter.

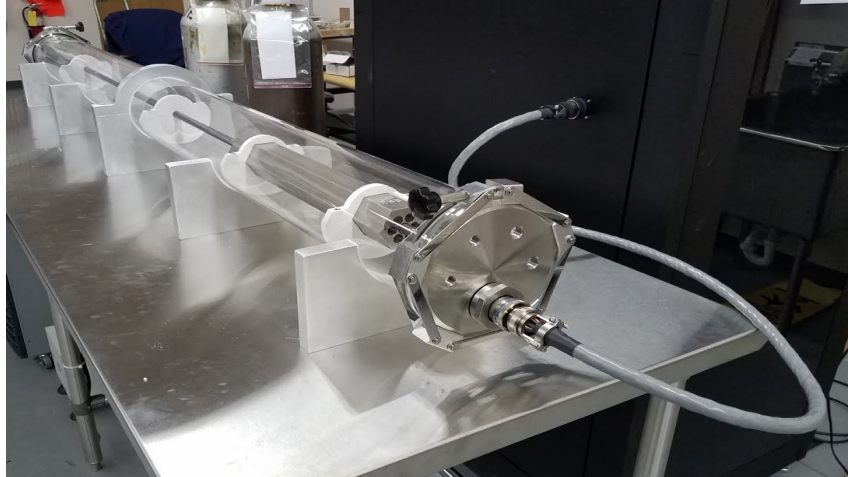

Figure 2. SPHERE test bed and seven-hole test article.

The objectives of the single heat-pipe testing include:

- Documentation of heat-pipe thermal performance under a wide range of heating values and operating temperatures
- An observation of heat-pipe startup and transient operation
- Development of effective thermal coupling methods between the heat-pipe's outer surface and the core block and between cartridge heaters and the core block
- Measurement of heat-pipe axial temperature profiles during startup, steady-state, and transient operation using thermal imaging and surface-temperature measurements, performing calorimetric measurements with water-cooled gas-gap calorimeter
- Determination of heat-pipe operational limits, and testing under both vacuum and inert gas conditions.

Thermal performance of the operating heat pipes will be determined by the measurement of a heat-pipe's heat removal capacity as a function of the operating temperature. The heat removal rate is equal to the total heater power input, measured by power meters, minus any heat losses as determined by a combination of measurements and analysis. Startup and transient behavior are characterized by acquisition of time-dependent temperature-response data of the whole system, including the heaters, core hex block, and heat-pipe. The effectiveness of the thermal coupling technique between the heaters and the core block—as well as between the heat-pipe and the core block—is determined by the measurement of the temperature of the heaters, core block, and heat-pipe over a range of operating conditions. Ideally, the outer sheath of the heaters should have a temperature very close to that of the heat-pipe. Large temperature drops between the heater sheath and the core block or between the core block and the heat-pipe indicate large thermal resistances in those locations that would result in high heater and core block temperatures within the required heat transfer rate design range. The heaters and heat-pipe will be centered in their respective holes in the core block using wire wound around their outer diameters. In order to have good (i.e., low) thermal resistance between the cartridge heaters and the block, thermal interface material will be added to the gap between the heaters and the core block. Different configurations of heat-pipe with and without thermal interface materials will be tested. Heat-pipe axial temperature profiles will be monitored during startup, transient, and steady-state operation using a combination of spot-welded surface thermocouples (TCs) and thermal imaging techniques.

The working fluid of the heat-pipe is sodium, and the wick structure will be specific to the supplier. The total quantity of sodium in each heat-pipe is typically small (e.g., ~60–80 g). From the standpoint of operations, the heat pipes are fully closed, sealed, and welded-shut test articles that will be operated within

their design limits, so no sodium handling will be required. The cartridge heaters have internal TCs to monitor their centerline operating temperature. Heater power control is achieved using Watlow Din-A-Mites silicon controlled rectifier (SCR)-based power controllers, based on a 4–20 mA control signal provided from the National Instruments SCXI data acquisition system, which interfaces with a LabVIEW virtual instrument for data acquisition and instrument control. Pressure inside the heat pipes will be sub-atmospheric even at the highest operating temperature, so any failure of the heat-pipe would not involve a pressurized release of material. Power to each heater is monitored continuously using precision power meters designed for measurement of SCR-controlled loads.

The following existing test article and heater configurations may be used. Other test articles may be constructed or delivered to the facility for testing. The design basis heat-flux value for the cartridge heaters is 3.8 W/cm^2 , based on expected microreactor-core power densities. For the 6-in. block, this power density yields 317 W per heater (for a total power of 1891 W), and for the 1 m block, each heater would operate at 2 kW for a total power of 12 kW with linear interpolations between the two. The cross-section geometry of the different core blocks is shown in Figure 3. The actual heat fluxes that will be applied during testing will be calculated by the heat transfer rating of the heat pipes. Heat-pipe operating temperatures will be limited to 750°C . Note that the vapor pressure of sodium is still well below 1 atm at this temperature. Therefore, overpressurization failure of the heat-pipe is not a safety consideration.

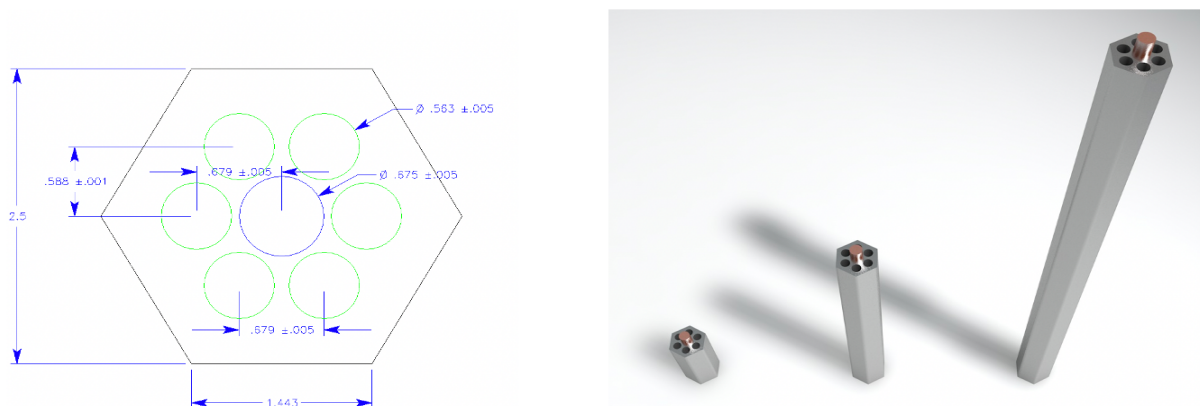

Figure 3. Cross-section geometry of a seven-hole core block for the single heat-pipe experiment (e.g., 6 in., 1/2 m, 1 m), not to scale.

2.2 Microreactor Agile Non-Nuclear Experimental Test Bed

To support the development of microreactor technology, INL established a 250 kW, electrically heated microreactor test bed to enable experimental evaluation of a variety of microreactor concepts. MAGNET was constructed at INL to assist with the development, demonstration, and validation of microreactor components and systems. The purpose of this test bed is to support technology maturation that will reduce uncertainty and risk relative to the operation and deployment of this unique class of systems. The stakeholders for this test bed include microreactor developers, energy users, and regulators. Regulators can be engaged early in the design and testing to expedite regulatory approval and licensing.

2.2.1 MAGNET for Integrated Energy Systems Testing

MAGNET is one component of the Dynamic Energy Transport and Integration Laboratory (DETAIL). DETAIL is located in the Energy Systems Laboratory at INL and is collocated with the Microgrid Research Laboratory, the Real-Time Digital Simulator, multiple high-temperature electrolysis demonstration units, the Electric Vehicle Charging Laboratory, and the Thermal Energy Distribution System (TEDS). DETAIL will allow demonstrations of fully integrated energy systems.

MAGNET will be integrated with TEDS and DETAIL by means of a heat exchanger and piping. This heat exchanger removes heat from the MAGNET gas-cooling stream and transfers it to the heat transfer oil in TEDS, where it can be distributed to either a dummy heat load or to a steam generator serving a high-temperature steam electrolysis demonstration unit to produce hydrogen.

Integrating MAGNET with other systems in DETAIL will enable achievement of one of the prime objectives of MAGNET: testing the interface between the test article and standalone heat exchangers with power generation of process heat loads. MAGNET will also serve as an alternate heat source in place of the electric heater in TEDS. See **Error! Reference source not found.** for an overview of how MAGNET fits into DETAIL.

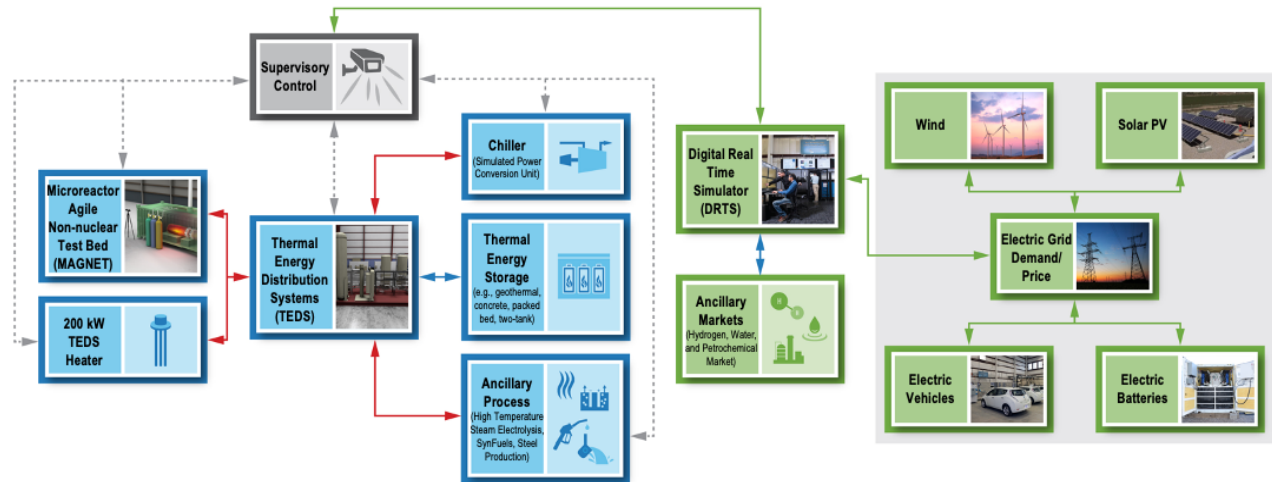

Figure 4. DETAIL overview.

A process flow diagram of MAGNET and a graphic of the MAGNET environmental chamber are shown in Figure 5. Design specifications for MAGNET are as follows:

- Test bed designed for up to 250 kW electrical power to core heaters
- Maximum test article temperature of 750°C.

The environmental chamber design requirements include:

- Vacuum (10^{-4} torr) or inert gas atmosphere
- 5 ft × 5 ft × 10 ft capacity, with a test article support platform on rails
- Liquid-cooled chamber walls
- Flanges for gas-coolant connections, instrumentation feedthrough ports, heater power feedthrough ports, and viewing windows.

The gas-coolant flow loop design requirements are:

- Air or inert gas coolant, such as He or N₂
- Up to 250 kW heat removal from the test-article
- Design pressure of 22 barg
- Design temperature of 650°C in the hot section
- Gas-flow rates up to 43.7 ACFM at 290 psig (initial single-compressor configuration):

- N_2 mass flow rates up to 0.5 kg/s
- He-gas mass flow rates up to 0.07 kg/s
- Feedback control for constant mass flow rate
- Compressor speed control via variable frequency drive.
- Test loop allows for integration of a power conversion unit (PCU) or auxiliary systems (e.g., process heat, etc.) via the heat source heat exchanger.

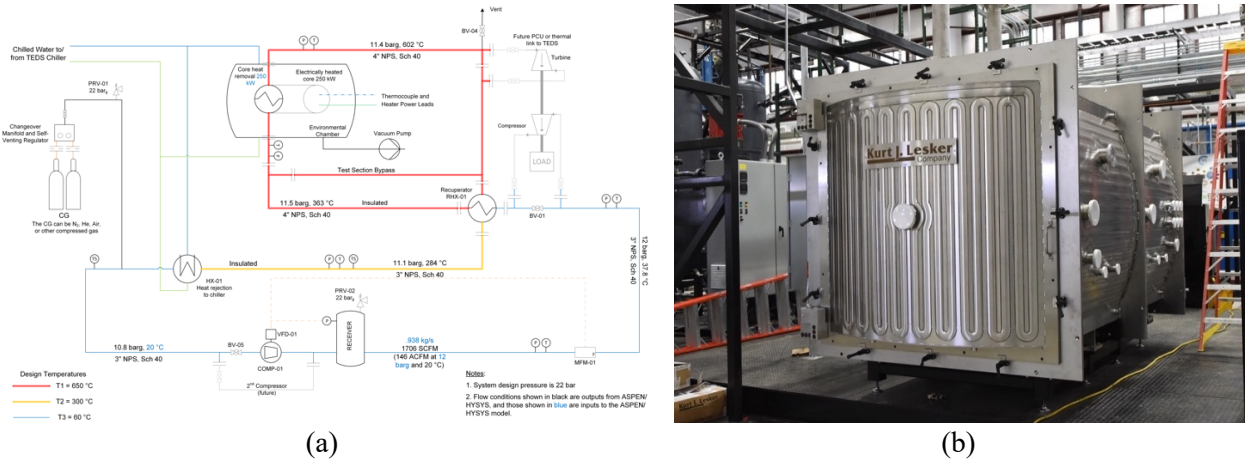

Figure 5. (a) MAGNET process flow diagram and (b) environmental enclosure.

Within MAGNET, systems and components can be safely tested, providing valuable information on failure modes, operating regimes, and thresholds. The goal is to provide a test bed that is broadly applicable to multiple microreactor concepts. Various types of microreactors are proposed, which can be classified according to their core-cooling method: heat-pipe, gas-cooled (pebble bed or prismatic), molten-salt, liquid-metal, or light water. Each reactor type poses a different set of design and operational challenges and has performance claims stated by commercial vendors that have not been independently verified or validated through rigorous testing. The initial set of tests to be performed in MAGNET are targeted towards demonstrating the feasibility and performance of heat-pipe-cooled reactors. However, the test bed is able to accommodate other microreactor designs. MAGNET was constructed at INL with the following objectives and technical goals (Trellue et al. 2019):

- Provide displacement and temperature data that could be used to verify potential design performance and to validate accompanying analytical models
- Show structural integrity of core structures against thermal stress, strain, aging and fatigue, creep, and deformation
- Evaluate the interface between heat pipes and a heat exchanger for geometric compatibility, heat-pipe functionality, and heat transfer capabilities
- Develop potential high-performance integral heat exchangers based on advanced manufacturing techniques, incorporating high-efficiency heat transfer from the heat pipes to the power-cycle working fluid
- Test the interface between the heat exchanger and integrated systems for power generation or process heat applications
- Demonstrate the applicability of advanced fabrication techniques, such as additive manufacturing or diffusion bonding, to nuclear reactor applications

- Identify and develop advanced sensors and power conversion equipment, including instrumentation for autonomous operation
- Study cyclic loading and reactivity feedback
- Enhance readiness of the public stakeholders—particularly DOE laboratories and the NRC—to design, operate, and test new types of high-temperature reactor components
- Capture data relevant to the development of autonomous-microreactor structural-integrity monitoring systems (e.g., digital image correlation [DIC]) and use that data to develop and verify models/systems for system integrity monitoring.

2.2.2 Heat Exchanger Testing

MAGNET is capable of testing multiple configurations of high-performance heat exchangers, both integral and standalone, with a maximum duty of 250 kWt from electric-resistance heaters and compressed nitrogen or helium heat removal. Scaling analyses will verify applicability of heat exchanger testing in MAGNET to a heat exchanger of larger duty.

The main objectives for testing integrated heat exchangers will focus on:

- Measuring cold-side fluid-mass flows, temperatures, and pressure drops
- Measuring heater power
- Testing the full operating range of the heat exchanger to ensure there are no leaks or loss of performance
- Confirming vendor design data and performance characteristics
- Evaluating materials and fabrication methods
- Validating stress analysis models.

The heat exchangers to be tested in MAGNET will be of a compact variety—i.e., scaled-down versions to illustrate proof of concept for novel designs or to test specific features of the heat exchanger. The heat source heat exchanger can either be an integral part of the test article or a separate component. For example, a printed-circuit heat-pipe heat exchanger was designed by INL, fabricated by Clean Energy Systems, and will be tested in parallel with the test article experiments. Advanced manufacturing is being explored as a method for fabricating novel designs that operate over the full range of conditions expected during microreactor operation.

2.2.3 Power Conversion

A PCU will be integrated with MAGNET as a secondary loop. The focus of this integration is on obtaining measurement data that will be useful in evaluating performance and enabling trade studies of various microreactor concepts and components. A heat exchanger will be integrated with MAGNET to transfer thermal energy to the PCU, as shown in Figure 6. Performance modeling using Aspen HYSYS or other software will be used to guide the testing. The primary objectives of the tests with the PCU are to:

- Assess the coupling between the PCU and MAGNET test articles
- Explore accident scenarios, such as sudden loss of load from the PCU or failure of the microreactor heat exchanger
- Evaluate the effects of startup, shutdown, and transients from the reactor on the PCU and vice versa
- Establish a set of procedures to inform operation of the entire microreactor system (i.e., reactor, heat exchanger, and PCU)
- Outline potential design specifications for PCUs to supply to vendors

- Obtain microreactor operating data that can be used by industry to select power-cycle designs that meet safety and performance requirements.

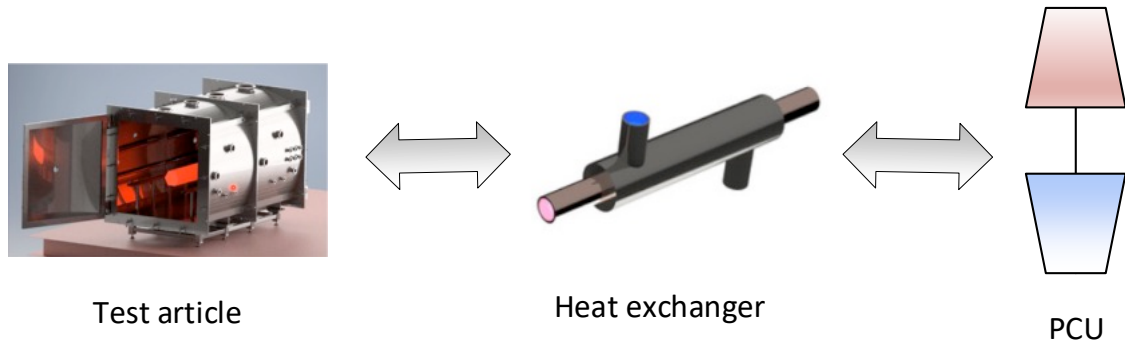

Figure 6. The heat exchanger removes heat from the test article and supplies it to the PCU (Guillen 2020).

In order to provide capabilities for integrated power conversion testing, a modified, commercially available Capstone C30 microturbine unit (Capstone 2020) has been acquired, as shown in Figure 7, and will be integrated with MAGNET. Figure 8 shows the key components of the PCU, including the compressor, turbine, alternator, internal recuperator, gas cooler, and power management and distribution subsystem. Generated power can be fed to the electrical heaters in MAGNET to supplement externally supplied electricity or to a load bank as part of the collocated Microgrid Research Laboratory. The cycle is completely closed. Gas flows through the compressor and recuperator into the heat source heat exchanger, into the turbine, back into the recuperator, and finally into the gas cooler for the rejection of waste heat.

The C30 recuperator is an annular gas-gas heat exchanger that is physically integrated within the PCU housing. The heat source heat exchanger can be a gas-gas or liquid-gas heat exchanger, depending upon the reactor design. This PCU has been modified to use electrical heating (Wright 2006) rather than fossil-fuel combustion to provide a maximum power output of ~30 kWe in a closed Brayton-cycle loop with nitrogen as the working fluid. A detailed description of the PCU and the integration into MAGNET is given in Guillen (2020). The performed analyses indicate the PCU will be capable of operating over a range of steady-state and transient conditions to evaluate test article heat transfer performance in representative operational scenarios (Guillen 2021). Normal, off-design operation and dynamic stability of the PCU are analyzed, while a proposed set of tests for the power control schemes and heat source/PCU coupling are outlined.



Figure 7. Modified Capstone C30 unit in shipping crate.

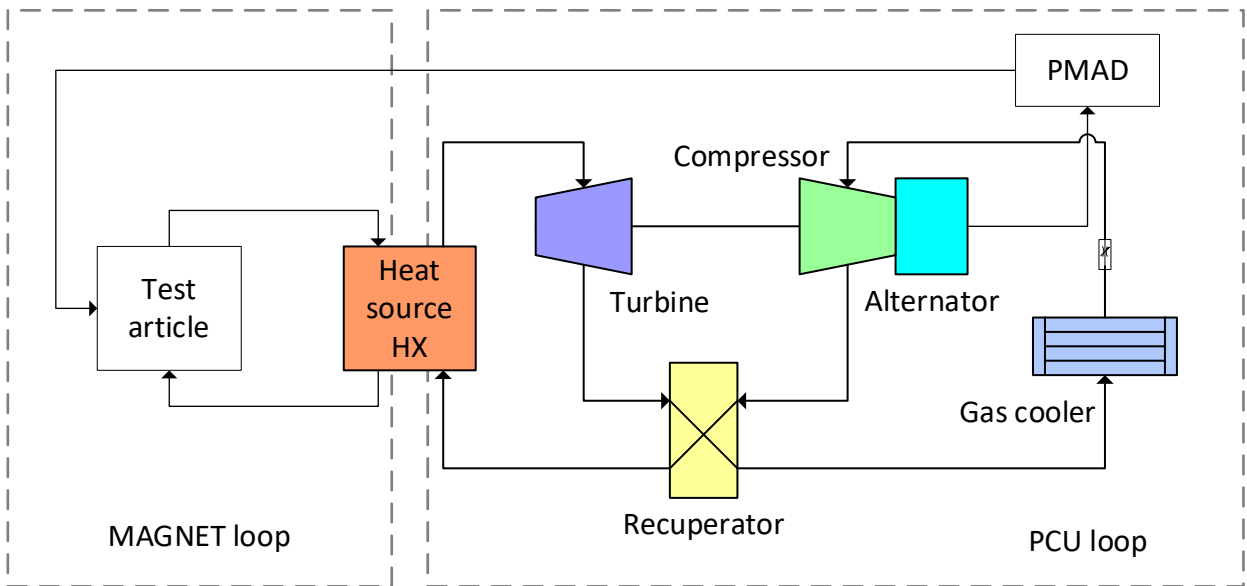

Figure 8. Layout of PCU loop connected to MAGNET loop by the heat source heat exchanger.

The integration of the PCU with MAGNET provides an opportunity to train operations staff in the Energy Systems Laboratory in the use of a small gas turbine. It also leverages the facility to test other power conversion systems and technologies. Users will have the ability to interface with the controls and obtain feedback on certain aspects of the integrated microreactor/PCU system. Potential future studies include the creation of a digital twin to facilitate further understanding of the interaction between the simulated microreactor and the PCU. Data from the coupled system could be used to develop and validate anomaly detection algorithms to facilitate remote or autonomous operations. Development of a dynamic system model will enable further investigation of transient operation (e.g., response times, system performance, control system parameters, etc.) of the coupled heat source/PCU system. The coupled system could also be used to test small-scale waste heat recovery systems. Ultimately, parameters such as net

power generation, power-cycle efficiency, capital and operating costs, startup and shutdown procedures, ramp rates, and thermal transients in a reactor core during load-rejection scenarios will be important to specify the most appropriate PCUs for a given microreactor application. The experience gained with the C30 can be leveraged for testing other power conversion systems and technologies.

Additionally, MAGNET offers a platform for testing other heat-to-power or process heat applications. Thermoelectrics can be integrated as a topping cycle for power or a bottoming cycle for waste heat recovery. A combined thermoelectric generator (TEG)/thermoelectric cooler system—where the cooler is powered by the generator to use reactor heat to provide cooling without the need for external power—can be experimentally evaluated. Thermodynamic cycles can be explored, such as the organic flash cycle, which provides better temperature matching to the heat source than can conventional organic Rankine cycles. Nascent concepts, such as thermo-acoustic devices, may be appropriate for applications where simplicity, reliability, or cost, rather than efficiency, are the driving factors. Successful testing of new concepts could lead to commercialization of technologies that make microreactors more efficient and practical. A key factor in making thermal management devices more competitive is design optimization to maximize performance and minimize cost.

2.3 Advanced Heat Removal Systems

The goal of the advanced heat removal work package in the U.S. DOE Microreactor Program is to identify and demonstrate advanced technology for eventual microreactor applications. A wide variety of reactor types are under consideration, including sodium-cooled fast reactors, molten-salt reactors, very high-temperature gas reactors, and heat-pipe reactors. One issue common to all microreactor designs is the need to remove heat from the core. Microreactors will feature passive safety systems that can prevent overheating, reactor meltdown, or damage to nearby systems and structures. Heat removal is a required element of microreactor design to transport heat from the core to a heat exchanger and, eventually, a PCU or auxiliary application, such as process heat, hydrogen production, or desalination (Sabharwall 2020). Transport of heat from the reactor to power conversion or auxiliary systems could potentially integrate with renewable energy sources. Cooling of microreactors presents unique challenges related to potentially harsh operating conditions.

Small size and power requirements, coupled with factory-built, standardized modular designs, offer unique advantages that can be captured by innovative designs made possible via advanced manufacturing (Morton 2020). Heat removal technologies must support deployment in varied locations, including those without access to large streams of cooling water, and would serve to protect systems from damage due to excessive heat. MAGNET can facilitate experimental testing of a spectrum of diverse approaches to thermal management that can be applied to advanced, high-performance heat removal systems to further enhance the expected performance of microreactors (Gorjup 2021). Concepts at different stages of technical maturity that can push the boundaries of thermal management in present-day nuclear technology can be rapidly prototyped using advanced manufacturing methods.

Different types of heat removal devices for microreactors include latent-heat transfer devices, such as various types of heat pipes, and sensible heat transfer concepts, such as heat spreaders and thermal interface materials. Heat-transport technologies that transport heat via liquid-vapor phase change include various types of heat pipes, including constant- or variable-conductance heat pipes, liquid- or vapor-trap diodes, thermosyphons, oscillating heat pipes, loop heat pipes, and vapor chambers used in various industries. These inventions and devices have largely been developed for application in other fields, but they can be borrowed for novel applications as heat removal systems in microreactors. Thus, these devices need to be tested and demonstrated in prototypic operating environments to prove their safety and efficacy. Novel ideas, such as patterned surfaces or the use of nanofluids, can be tested in SPHERE.

SPHERE or MAGNET can be used to test thermal management materials—e.g., thermal interface materials, heat spreaders, porous structures, heat sinks—and engineered materials that offer radiation resistance and protection from ballistics or fire. Shrouds or protective enclosures can be engineered to

enclose either the entire microreactor or selected subsystems. Additionally, novel concepts using porous metal foams, lattices, or honeycomb structures offer solutions for compact heat exchangers. A porous material can be used to insulate or enhance heat transfer according to its thermophysical properties and arrangement. Materials that interact with neutrons can be used for semipassive in-core heat removal (Guillen 2021). Ex-core applications for thermal, structural, and radiation protection include composite metal foams, metal-carbon nanotube composites, or boron nitride composites.

Radiation-resistant or neutron-absorbant heat-sink materials can be evaluated in the Advanced Test Reactor (ATR) or Transient Reactor Test Facility (TREAT) at INL. The high-flux neutron attenuation and geometrical stability of the material and changes to its thermal properties upon high-flux neutron irradiation have not been conducted before. Future studies will provide an important database that can be used to assess the performance of these novel materials in nuclear structures and correlate neutron-shielding effectiveness.

2.4 Test Articles and Instrumentation

The following test articles are available to the microreactor community for testing in the INL microreactor experimental facilities. Other test articles may be constructed or tested to meet the needs of the microreactor community.

2.4.1 Single Heat-Pipe Test Article

The single heat-pipe test article consists of a seven-hole hexagonal block. The central hole holds the single heat-pipe, as shown in Figure 3. The other holes around the perimeter contain commercial cartridge heaters. The interfaces between the block and the heat-pipe or heaters are filled with boron nitride. This creates an easily releasable and removable thermal interface between the components. The main objectives of testing for this assembly are to demonstrate:

- Heat-pipe startup, steady-state, and transient performance with an indirect heat source
- *In operando* measurement of test article temperature profiles
- Comparative measurement of dimensional changes between operations
- Validation of embedded sensor techniques for the 37 heat-pipe test article
- Provision of data for code validation efforts.

Additional instrumentation is being incorporated into the seven-hole test article to provide more information regarding thermal and mechanical environmental conditions. The gas-gap calorimeter described in Section 2.1 will provide information regarding steady-state heat rejection from the heat-pipe, but additional instrumentation is required to understand the origin of heat losses from the test article and its temperature distribution. Temperature distributions are especially important because they are directly related to thermal stresses in the monolith and at the interfaces between the monolith and the fuel (cartridge heaters in this case), as well as the heat-pipe.

A seven-hole test article has been fabricated with two Type K TCs directly embedded in its walls using an ultrasonic additive manufacturing (UAM) process (Hehr 2017, Petrie 2020a). The test article also includes embedded spatially distributed fiber-optic strain sensors (Petrie 2020b, Petrie 2019a, Petrie 2019b) and cavities for inserting spatially distributed fiber-optic temperature sensors (Wood 2014, Sweeney 2020). Figure 9 shows pictures of the sensor embedding process and the final seven-hole test article after sensor embedding and post-embedding machining. The sensors survived the embedding process and are currently being characterized at Oak Ridge National Laboratory (ORNL) prior to being sent to INL for testing in SPHERE.

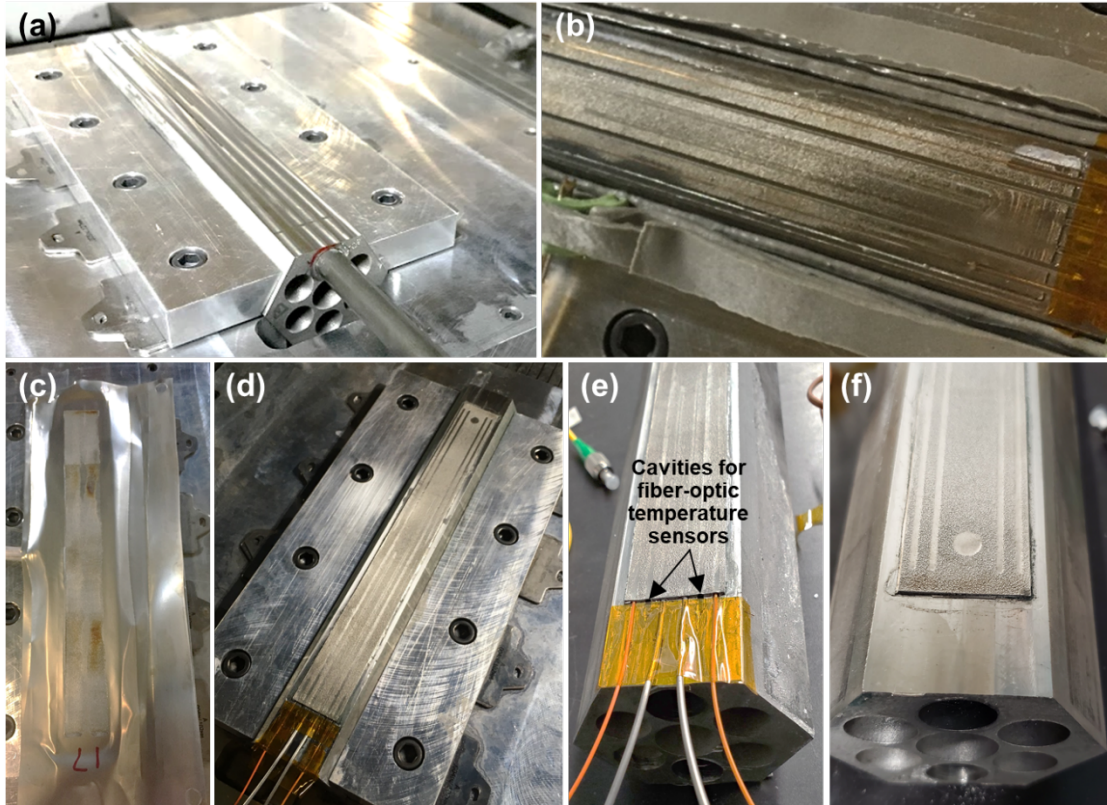

Figure 9. Pictures of a stainless steel mini hex block during sensor embedding show: (a) the part in its fixture; (b) UAM layering; (c) completion of the UAM layering process; (d) post-embedding machining; and (e,f) the finished part.

In addition to traditional and embedded sensors, DIC has shown itself to be a very attractive technique for measuring strain and deformation at high spatial resolution as a non-contact, imager-based technique that can potentially be used to measure strain and deformation in two-dimensional (2D) or three-dimensional (3D) views and will be used in the MAGNET facility. In a typical DIC measurement, a speckle pattern is applied to the structure under test and observed as it undergoes deformation or loading using imagers, as shown in

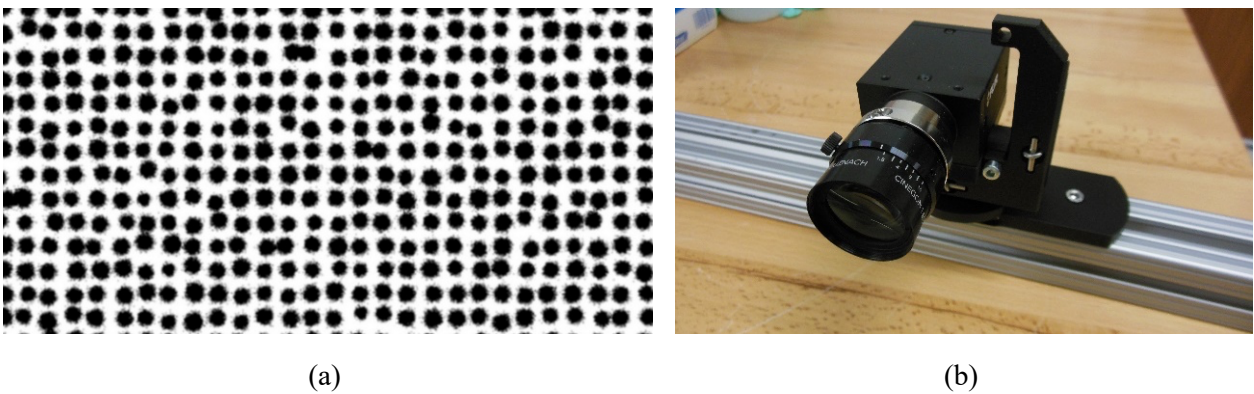

Figure 10.

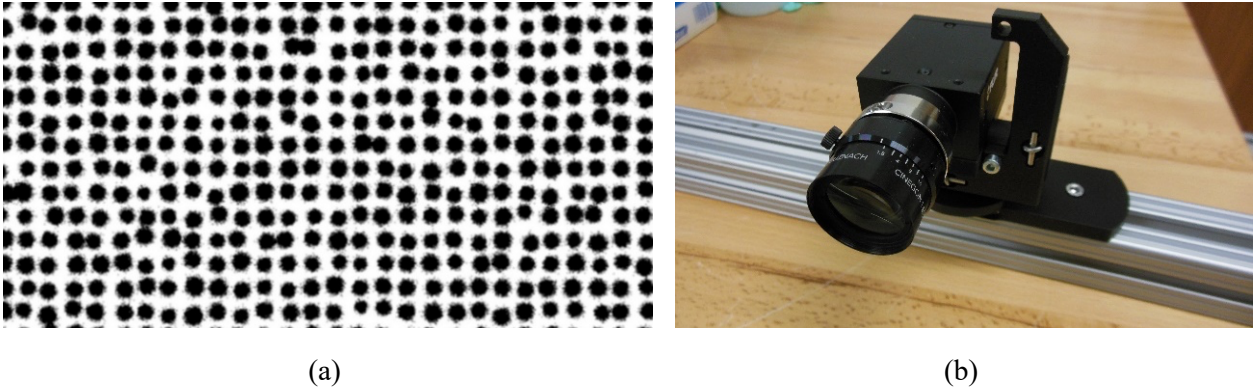

Figure 10. (a) Example of a speckle pattern synthetically generated using Gorjup (2021). (b) Imager used for DIC.

The high-temperature of the microreactor components make deployment of DIC in MAGNET more challenging. The first obstacle to overcome is the thermal glow of the core block that may overwhelm the contrast of the texture pattern, preventing correlation. For DIC, diffuse is usually better than specular reflection, suggesting a dull surface with relatively high emissivity will perform best. Starting with the texture pattern, surface roughness can be enhanced with sandpaper (Grant 2009) or through application of a high-temperature compatible painted speckle pattern (Berke 2014, Sharma 2009, Pan 2011). To avoid saturation, a blue or ultraviolet band-pass filter in front of the imager will be explored. High temperatures will also result in haze effects from convection currents, which distort the image and introduce error to DIC measurements. Several countermeasures (Lyons 1996, Novak 2011, Leplay 2015, Su 2015, Ma 2019, Hao 2017, Bao 2019) will be investigated to improve the accuracy of high-temperature DIC against heat distortion.

2.4.2 Distributed Temperature Sensors for Heat Pipes

Testing and deployment of candidate sensing technologies has been accelerated at the SPHERE facility. This facility has tested a single, 78.75 in. long, 0.625 in. outer diameter (OD), sodium-filled heat-pipe ordered from Advanced Cooling Technologies, Inc. (ACT). A feature unique to this heat-pipe is that it was specified with a 78.5 in. long, 0.125 in. inner diameter (ID) thermowell, as shown in Figure 11, which extends through the vapor region. This thermowell does limit overall heat-pipe performance; however, it was included to facilitate evaluation of various distributed temperature sensors at expected heat-pipe temperatures.



Figure 11. Thermowell (0.125 in. ID) in sodium-filled heat-pipe (0.625 in. OD).

Multisegment sensors offer the ability to measure several discrete locations along their lengths while only requiring a single lead into the experiment. Temperature-detection sensors under investigation that may be of interest to MAGNET users include distributed TCs, distributed optical fiber-based temperature sensors, and distributed ultrasonic thermometers (UTs).

Two types of distributed TCs have been fabricated for deployment in SPHERE and MAGNET, the distributed high-temperature irradiation-resistant thermocouple (HTIR-TC) and distributed Type K TCs. The HTIR-TC is a robust nuclear-compatible TC (Skifton 2019) that is not necessary for non-nuclear testing, but was investigated to understand the feasibility of its use in future microreactor nuclear evaluations. In addition to the HTIR-TC, a commercially fabricated Type K multipoint TC was procured from Idaho Laboratories Corporation that has 10 TC junctions, 7 in. from each other, inside of a 0.118 in. OD stainless steel sheath. The 10-point TC has been installed and successfully evaluated in SPHERE for initial startup tests, as shown in Figure 12, up to approximately 740°C.



(a)

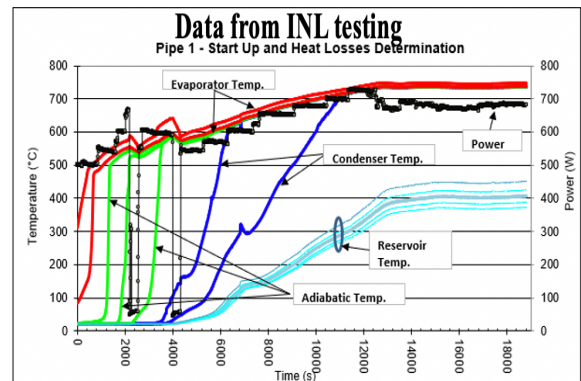

(b)

Figure 12. (a) Ten-point Type K TC in SPHERE and (b) test results.

Two types of distributed fiber-optic temperature sensors that were previously developed for irradiation-testing experiments have been fabricated for deployment: a Type-II fiber Bragg grating (FBG) optical fiber and a single-mode silica optical fiber (McCary 2017). The FBG fibers shown in Figure 13 were fabricated with nine discrete gratings, spaced 9.84 in. apart, and are intended to be operated up to 650°C with minimal drift and as high as 750°C, with a larger drift expected before failure. The single-mode silica optical fiber is an unaltered fiber that uses the natural defects and density fluctuations in the amorphous glass to resolve temperature approximately every 0.10 in. up to 500°C. Both fibers have been installed in 0.063 in. OD \times 0.010 in. wall stainless steel tubes to aid in installation and removal.

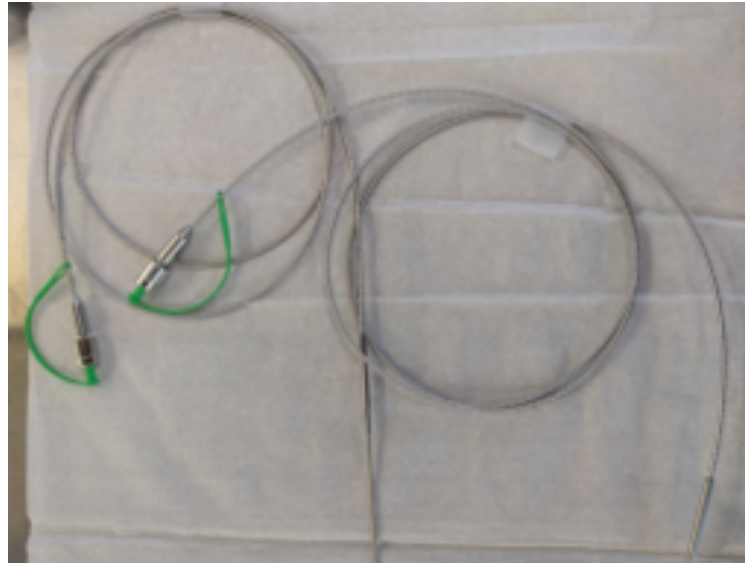

Figure 13. Fabricated Type-II FBG.

A multipoint UT that was previously developed for irradiation-testing experiments (Daw 2018) has been fabricated, as shown in Figure 14. The UT was fabricated with a 0.084 in. OD with eight points, located at 22, 28, 35, 48, 60, 82, 89, and 96 in. from the transducer end. The unit can be operated up to 1000°C.

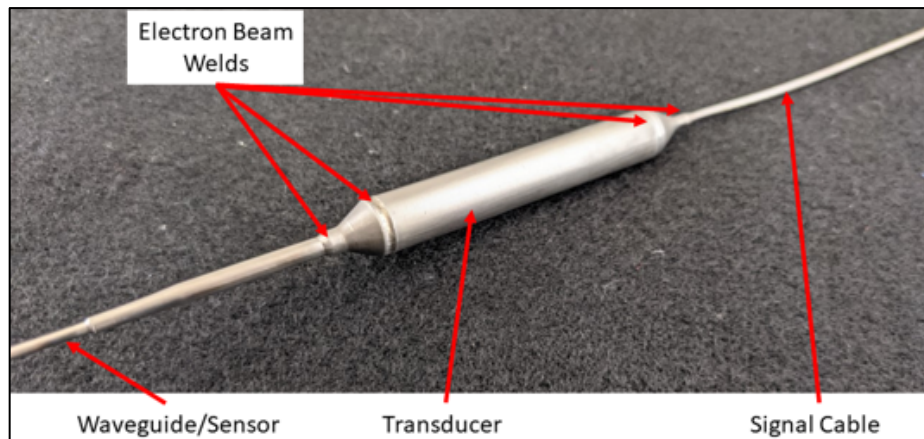

Figure 14. UT transducer housing and connections.

Additional testing will evaluate each sensor design for performance and survivability during heat-pipe operational-limit testing, under both air and inert gas conditions. This will include a measurement of conductance-gap testing using these small-diameter temperature sensors. This concept is demonstrated in

Figure 15 on a heat-pipe mockup tube by laser welding a helically wrapped tube with distributed fiber sensor slid inside. A similar concept will be used to attach multiple small-diameter single-point TCs and UTs.

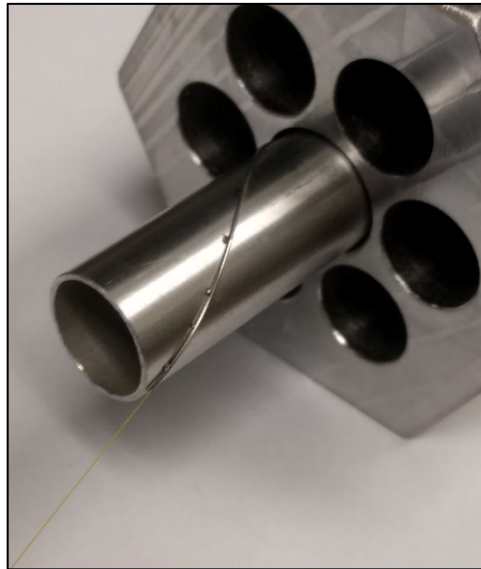

Figure 15. Mockup heat-pipe with fiber-optic wire wrap in test block.

2.4.3 Thirty-Seven Heat-Pipe Test Article

The initial, large-scale, multi-kW test article to be installed in MAGNET is an approximately 2 m-long core block subassembly with 37 heat pipes and 54 cartridge heaters in the core, as shown in Figure 16. Total heater power for this assembly is 75 kW. The main objectives of testing for this assembly are to demonstrate:

- The heat-pipe to heat exchanger interface in a prototypical geometry representative of that in a full-scale microreactor
- Heat removal section (e.g., heat exchanger performance)
- Advanced heat-pipe charging methods
- Heat-pipe startup, steady-state, and transient performance
- Measurement of test article temperature profiles and dimensional changes during operation
- Passive heat removal
- Testing of a failed heat-pipe and its effect on the periphery and/or center
- Transient simulated reactivity feedback control of the heaters.

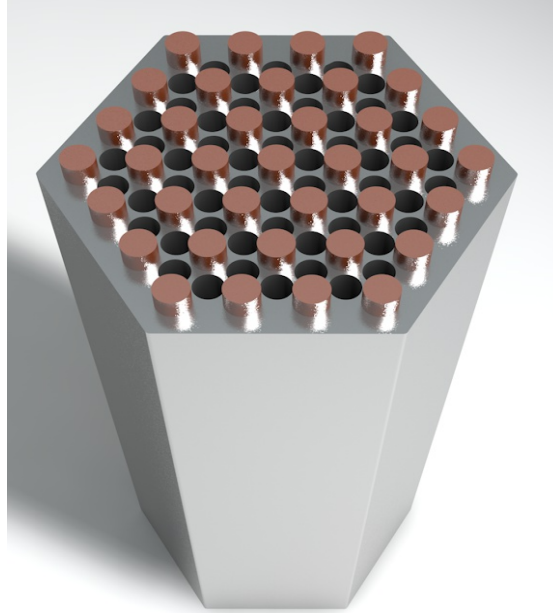

Figure 16. Cross-section geometry of the 91-hole (54 heater rods and 37 heat pipes) 75 kW core block.

In addition to demonstrating seven-hole articles and a 37 heat-pipe article, other components and technologies that will be tested at the test bed include gas-cooled core test articles, alternate monolith materials, moderator materials, advanced heat exchanger designs, power conversion units, and process heat applications.

2.5 Planned Tests

Test articles being built for demonstration in the non-nuclear test bed will provide required data and information on the capability of the test bed and instrumentation and control systems. Initial system shakedown testing of both SPHERE and MAGNET allowed the instrumentation, control, and other components of the test bed to be verified prior to experimental testing on test articles, which will be tested after operation has been proven. Recently, the shakedown testing for SPHERE was completed, and operation of MAGNET facility was demonstrated. For further details, see Sabharwall (2020) and Morton (2020), respectively.

The single heat-pipe test article campaign will primarily focus on testing heat-pipe performance. This testing regime will consist of cycles of startup, shutdown, and transient operations of the test article. These thermal cycles will assist preliminary validation of the manufacturing techniques and will involve various steady-state power levels. During this time, the heat-pipe, block geometry, and heaters will be monitored via multipoint TCs, thermal imaging cameras, and strain gauges. Advanced measurement techniques, such as DIC, will also be used and compared to the traditional measurements. Below is a list of tests planned for both the single and 37 heat-pipe test article campaigns:

- Preliminary testing of cartridge heaters, power control and measurement, calorimetry, and thermal coupling of heaters to the core block using a water-cooled simulated single heat-pipe test apparatus with a seven-hole core block
- Single heat-pipe tests using ACT heat pipes with seven-hole core blocks of different lengths to characterize low-power heat-pipe performance during startup and at steady-state conditions and thermal imaging of transient heat-pipe operation, tested under both vacuum and inert gas conditions

- Single heat-pipe tests using ACT heat pipes with seven-hole core blocks of different lengths, characterizing high-power heat-pipe performance during startup and at steady-state conditions and performing calorimetric measurements with water-cooled gas-gap calorimeter to determine heat-pipe operational limits
- Single heat-pipe tests using Los Alamos National Laboratory (LANL) heat pipes with seven-hole core blocks of different lengths to characterize low-power heat-pipe performance during startup and at steady-state conditions with thermal imaging of transient heat-pipe operation, tested under both vacuum and inert gas conditions
- Single heat-pipe tests using LANL heat pipes with seven-hole core blocks of different lengths to characterize high-power heat-pipe performance during startup and at steady-state conditions and performing calorimetric measurements with a water-cooled gas-gap calorimeter to determine heat-pipe operational limits.

The 37-hole test article experiments will focus on thermal cycling and observing the response of material components to a greater degree. Additive manufacturing methods and their capabilities will be evaluated by nondestructive testing. Visual and X-ray inspection for cracks and delamination of the joints are of particular interest. Operational testing of the system will include a similar suite of thermal imaging and direct-contact temperature measurements, as well as strain measurements via gauges and DIC. These measurement techniques will have been validated and refined in the single heat-pipe test article test campaign.

After initial thermal cycling tests and examination, steady-state operation for an extended 1000-hour test will be performed. The other major outcome of the 37-hole test article test campaign will be the testing of an integrated, advanced heat exchanger. This operational test will also include transient operation of the system outside of shutdown and startup. The heaters will be controlled by a reactivity feedback model. The same measurement and analysis techniques applied to the core block will also be applied here. Preliminary accident conditions, such as loss of flow and loss of coolant, will be examined near the end of the initial test campaign. Finally, heat-pipe failure testing will be conducted to determine the effects and conditions that lead to cascading heat-pipe failure.

Both SPHERE and MAGNET will use National Instruments PXI-based data acquisition and control with a LabVIEW user interface to collect and record experimental data. Temperature, flow, strain, and electrical power are the basic parameters monitored and recorded. Additional advanced instrumentation, as needed, will be added to the data acquisition system. At the conclusion of the test article test campaigns, the test articles will remain available for modification and testing for other users.

Table 1 provides a list of non-nuclear tests being planned for both heat-pipe and gas-cooled reactor subassemblies. The tests are intended to support accelerated demonstration for heat-pipe- and gas-cooled microreactor systems.

Table 1. Planned and proposed non-nuclear tests to support accelerated demonstration.

Planned Experiments for SPHERE and MAGNET

SPHERE	Expected Timeframe	MAGNET	Expected Timeframe
7 Hole Article (2 kW) - Stainless Steel		Single Heat Pipe Test Article - Stainless Steel	
<ul style="list-style-type: none"> Preliminary testing of cartridge heaters, power control and measurement, calorimetry, and thermal coupling of heaters to core block using a water-cooled simulated single heat pipe test apparatus (initial testing) 	Completed	<ul style="list-style-type: none"> Advanced Heat Exchanger Test <ul style="list-style-type: none"> Operate advanced heat exchanger with low-pressure air coolant to determine heat transfer/ stress/performance. Operate advanced heat exchanger with high-pressure nitrogen coolant to determine heat transfer and thermal stress performance. Test condenser side and document heat transfer as a function of length. 	Summer 2021
<ul style="list-style-type: none"> Heat pipe performance testing at different orientations Determine integrity of stainless steel structure and welds/bonds used during fabrication Evaluate advanced temperature sensing methods on single heat pipe Evaluate creep, stress, and/or bowing in structural material Provide test data for fundamental understanding and code validation 	Summer 2021	<ul style="list-style-type: none"> Determine effect of gaps between heat pipes <ul style="list-style-type: none"> Perform test with multiple 7 hole test articles near each other but different amounts of space between them. Analyze effect of gas gap. 	Winter 2021-Spring 2022
<ul style="list-style-type: none"> High performance heat pipe testing Heat pipe failure test where thermal resistance between fuel cans becomes important Transient Heat Pipe Performance - fundamental understanding and code validation Apply DIC test method (strain measurement) Determine integrity of structure and welds/bonds during fabrication at high temperatures 	Fall-Winter 2021	37 Heat Pipe Article (75 kW) - Stainless Steel <ul style="list-style-type: none"> Test block with 37 heat pipes and integral heat exchanger. Characterize heat transfer from heat pipes to heat exchanger and assess thermal output. Potentially analyze failed heat pipe situation and/or other accident scenarios. Loss of active cooling, where decay heat is transported across several rows of fuel cell gaps to peripheral region surrounding the reactor core. Apply DIC test method 	Spring-Summer 2022

Proposed Experiments for SPHERE and MAGNET

SPHERE	Expected Timeframe	MAGNET	Expected Timeframe
<ul style="list-style-type: none"> Liquid metal flow measurements of heat pipe Interior In-operando X-ray examination of heat pipe 	2022	Other monoliths including: graphite, Mo, ZrC/SiC, and/or liquid <ul style="list-style-type: none"> Test heat pipe operation with cartridge heaters up to 750° C and analyze results Determine structural integrity and bonding/welding integrity. Evaluate creep, stress, and/or bowing in structural material 	Summer 2021
		Gas Reactor Test <ul style="list-style-type: none"> Test block with gas coolant for ability to produce thermal output evenly throughout the core. Characterize heat transfer to heat exchanger and/or PCU 	TBD
		Power Conversion Unit <ul style="list-style-type: none"> Characterize heat transfer from heat exchanger to PCU (from either 37 heat pipe and/or advanced heat exchanger articles). Determine how much power can be derived from PCU. 	2022

21-GA-05217

3. HYDRIDE MODERATOR FABRICATION AND TESTING

The addition of moderating material in a microreactor reduces fuel-mass requirements significantly. Traditional fission reactors use water as a moderator; however, the size and temperature requirements for microreactors preclude this (because with water as a moderator, the reactor cannot be made small enough nor run at a sufficiently high temperature). Metal hydrides can have a higher density of hydrogen per unit volume than water and operate at higher temperatures. Yttrium dihydride ($\text{YH}_x, x = 1.6\text{--}2.0$) is a highly desired moderating material because it retains hydrogen at high temperatures, leading to more efficient energy production than is possible at lower temperatures. Large-scale yttrium hydride fabrication equipment was installed at LANL as part of the Microreactor Program to generate high-temperature moderator material for further experiments. This new capability: (1) allows the fabrication of kilograms of YH_x per year; (2) increases part size from 2 to 12 in.; and (3) allows study of the effects of hydriding on joining (i.e., welding). This equipment can be used for ZrH or other material hydrides. Experiments planned with the yttrium hydride fabricated as part of the Microreactor Program are irradiation of material at INL's ATR and an integral critical experiment at the National Criticality Experiments Research Center (NCERC) in Nevada through LANL.

First, a new glovebox dedicated to hydride material was designed (see Figure 17), procured (that is, purchased), and installed. Several pieces of equipment were also identified and obtained for the effort:

- A new large-capacity planetary mill was transferred to the program and relocated for use in the glovebox
 - A new automated 20-ton press was transferred to the program and relocated for use in the glovebox
 - An instrumented hydriding furnace was procured and installed for samples up to 4 in. diameter \times 4 in. long
 - A large-capacity hydriding furnace was rebuilt and tested for samples up to 8 in. diameter \times 12 in. long.
- These efforts have increased LANL's capabilities for fabricating hydride materials in the Sigma facility.



Figure 17. Equipment needed for establishing a large-scale yttrium hydride capability (left to right): inert-atmosphere glovebox, automated mill, and automated press.

Pictures of the glovebox and new equipment are displayed in Figure 18. Figure 19 shows photos of the Sieverts hydriding setup obtained for yttrium hydride work.



Figure 18. New glovebox at LANL.

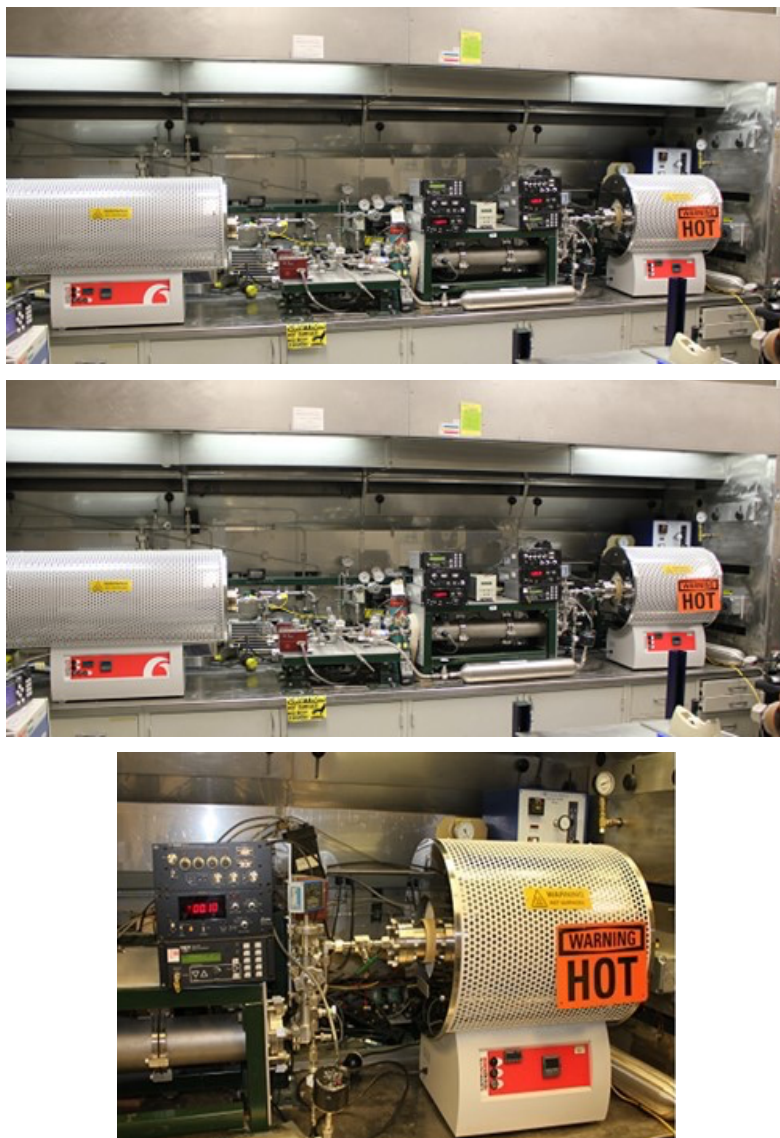

Figure 19. Sieverts apparatus.

3.1 Irradiation and Post-Irradiation Examination

ATR affords unparalleled irradiation capabilities for accelerated materials testing, with nine primary lobes that can be operated at different powers, atmospheres, pressures, and temperatures. Both instrumented and “drop-in” experiments can be accommodated. It is heavily used by the U.S. Navy, medical, space, private, and public research for wide-ranging applications. The facilities at INL’s Materials and Fuels Complex (MFC) offer state-of-the-art post-irradiation examination (PIE) capabilities that can investigate nearly any thermophysical and mechanical property of irradiated fuels and materials. These capabilities are employed currently by the Microreactor Program to investigate the suitability of high-temperature moderator materials for use in microreactors. ATR and MFC can support a wide variety of irradiation experiments, as described briefly in the section below, where yttrium hydride irradiation and PIE are used as an example of the utilization of the capability.

From a physics standpoint, a microreactor’s moderator must maintain an effective hydrogen density at high temperatures and fluences for an extended lifetime. The primary objective of the ATR irradiation experiment is to determine the effect of neutron irradiation on hydrogen concentration in the yttrium hydride. Evaluating hydrogen density and temperature stability under relevant operating conditions (i.e., temperature and fluence) requires knowledge of how much hydrogen is released at those conditions. Hydrogen content in pre-irradiated yttrium hydride can be quantitatively assessed using mass balance measurements, inert gas fusion (as performed using LECO interstitial gas analyzers), and hot vacuum extraction. X-ray diffraction can be used to qualitatively evaluate the yttrium hydride to determine the material phase composition of the hydride. For PIE, all of these techniques will be used, except for hot vacuum extraction, which is not available internally or externally for irradiated samples.

Although hydrogen measurements are of paramount importance, a wide range of other physical, thermomechanical, and microstructural measurements will be performed as part of PIE to measure other critical characteristics of irradiated yttrium hydride. These are summarized in Table 2.

Table 2. PIE measurements that will be performed on yttrium hydride samples.

Measurement	Purpose	Capability
Optical microscopy	General integrity of yttrium hydride	Optical microscopes
Neutron radiography	Bulk integrity of yttrium hydride Gross hydride distribution in samples	Neutron Radiography Reactor
Dimensional examination	Sample integrity and swelling	Optical microscopes, standard measuring devices
Mass balance	Determine change in mass due to irradiation—informs hydride concentration	Standard balances
Volume measurements	Swelling, deformation	Gas pycnometer
Phase identification	Stability of yttrium hydride as moderator	X-ray diffraction
Hydrogen concentration	Stability of yttrium hydride as moderator	LECO inert gas fusion and mass balance
Hydrogen migration	Stability of yttrium hydride as moderator	Glow discharge optical emission spectroscopy
Microstructure/metallography	Understand material evolution due to irradiation	Scanning and transmission electron microscopy
Elastic properties	Assess change in mechanical property due to irradiation	Pulse-echo
Sample hardness	Assess change in mechanical property due to irradiation	Nanoindentation

Measurement	Purpose	Capability
Physical density	Required fundamental property	Optical microscopes, gas pycnometer
Linear thermal expansion	Required fundamental property	Push-rod dilatometry
Heat capacity	Required fundamental property	Differential scanning calorimetry
Thermal diffusivity	Required fundamental property	Laser flash analysis

The ATR experiment is described in Figure 20, with pictures of the samples in Figure 21. PIE plans are given in Figure 22. More than 170 pellets were fabricated for this experiment, using both direct hydriding and metallurgic powder-sintering techniques. Behavior under irradiation at three different temperatures will be evaluated through PIE.

ATR irradiation design is in progress for insertion in 2021.

- Position: B2, North East

	Flux (n/m ² s)	Fluence (n/m ²)
Thermal	2.8e14	1.4e21
Fast (>0.1 MeV)	2.3e14	1.2e21

- Primary variables:
 - Temperature: 600, 700, 800°C.
 - YH fabrication method.

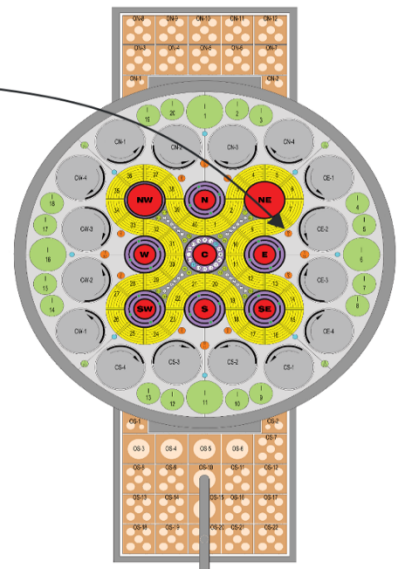

Figure 20. Details of ATR irradiation experiment.



Figure 21. (top) Yttrium hydride samples fabricated for ATR irradiation experiment. (bottom) Tantalum-zirconium-molybdenum alloy (TZM) cans to contain yttrium hydride.

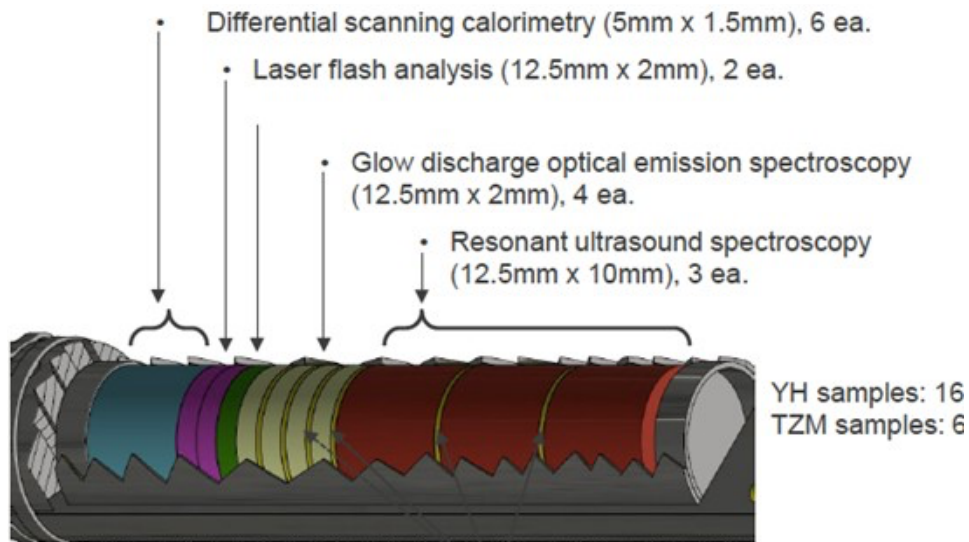

Figure 22. Description of PIE planned for the various yttrium hydride samples.

Additional irradiation testing is being performed independently at the MIT reactor. The MIT reactor affords easy access for in-situ instrumentation. YH and ZrH materials have been axially stacked in an irradiation capsule and fitted with thermocouple instrumentation to provide in-core temperature information. Plans are being developed to share the PIE results and specimens for additional PIE to study hydrogen retention as a function of axial temperature under irradiation.

4. NEUTRONICS TESTING

The Hypatia Experiment at LANL’s NCERC is used to perform criticality safety research on materials. Specifically, the mission of NCERC is to conduct experiments and training with critical assemblies and fissionable material. This includes experiments with systems that are at or near criticality in order to explore reactivity phenomena, benchmark materials and systems, and operate the assemblies in regions from subcritical through delayed critical. The Hypatia Experiment was used to investigate the reactivity of yttrium hydride using the Planet vertical-lift machine at NCERC. The following section provides details of this experiment and an overview of the experimental capabilities.

Simulations of the high-temperature moderating material yttrium hydride have shown that reactivity (neutron population) of a system increases slightly as the temperature increases if no other negative-feedback mechanisms are present. These effects are observed using simulated neutron cross-sections derived from diffraction and other measurements, but have not been validated experimentally, nor have any criticality experiments been conducted using yttrium hydride. This points to an overall lack of validation. An experiment to help provide missing experimental validation was planned and executed at NCERC, which is operated by LANL.

The purpose of Hypatia was to analyze reactivity behavior of yttrium hydride with a highly enriched uranium-fueled critical measurement at a range of steady-state temperatures. For the experiment, 14 2 in. yttrium hydride_{1,9} samples were machined, hydrided, arranged in 6 in. diameter Mo cans, and welded closed, as shown in Figure 23. Exact sample weights and shapes were measured and noted prior to the experiment. Each can contained roughly 670 g of yttrium hydride. Aluminum oxide electric heaters with NiCr heating elements were also present in the fuel column and were used in the experiment to increase the temperature of the cans of yttrium hydride. The fuel, yttrium hydride, electric heaters, and other axial reflectors were arranged in a central core column and surrounded by a thin aluminum guide tube, as observed in

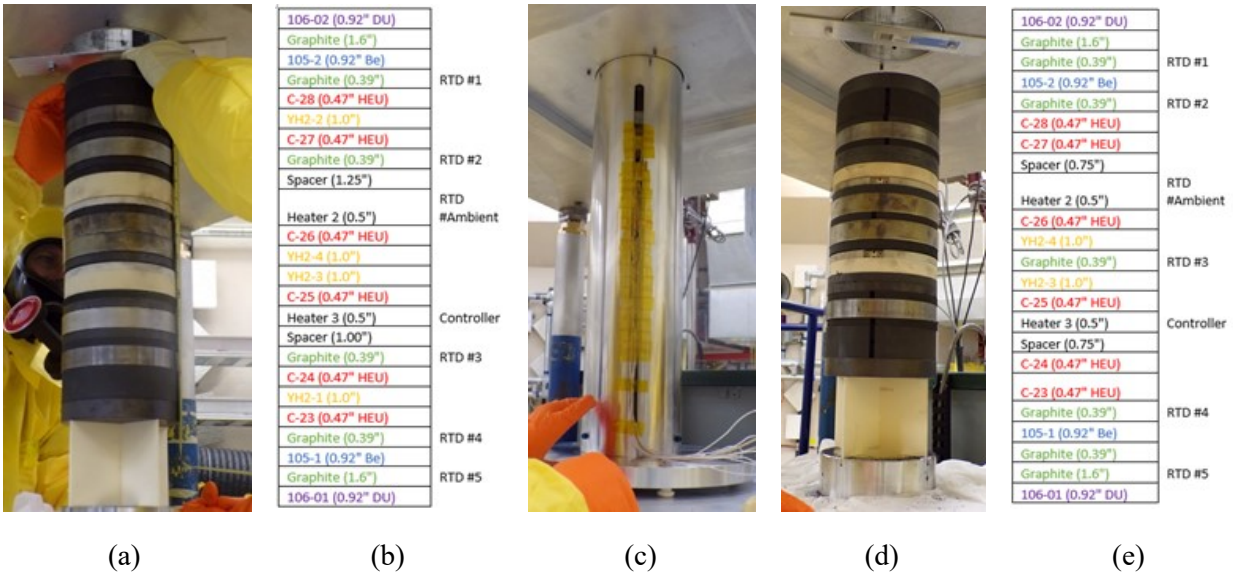

Figure 24. The two electric heaters were located near the fuel and the yttrium hydride samples, which were heated. Subsequently, the core column was vertically inserted into a beryllium reflector until criticality was achieved. These samples were heated to various temperatures, to a maximum of 330°C for the yttrium hydride. The full experimental setup is shown in Figure 25. Excess reactivity was measured at several different heater temperatures to obtain integral criticality feedback from the yttrium hydride as a function of temperature. Comparisons to simulations of the system with previously generated cross-sections were made at these steady-state temperature points. Temperature data were collected at seven points axially along the

core column to best understand system behavior. The system is set up such that the core column is easily reconfigurable to accommodate different materials, arrangements, and layering.

Reactivity was determined based on the reactor period and using reactor-kinetics parameters. The increased neutron population, as measured by neutron counters, is the exact parameter used to determine the reactor period. Figure 26 and Figure 27 show the temperature and neutron power and count rate, measured as a function of time for both configurations. The preliminary results show good agreement with model predictions—specifically, less than model predictions.

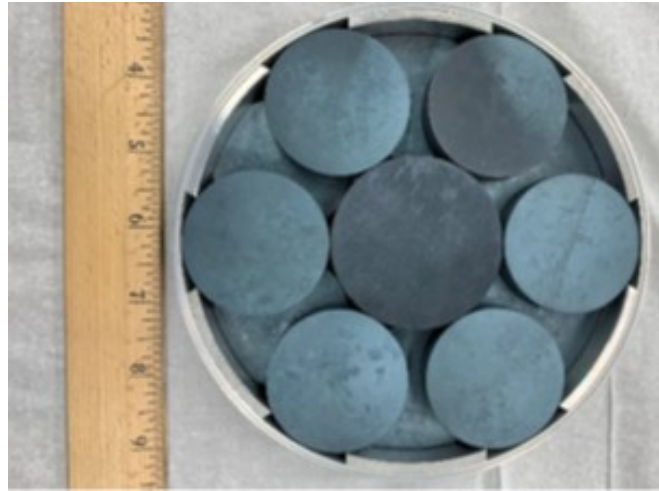

Figure 23. Yttrium hydride samples for the Hypatia Experiment.

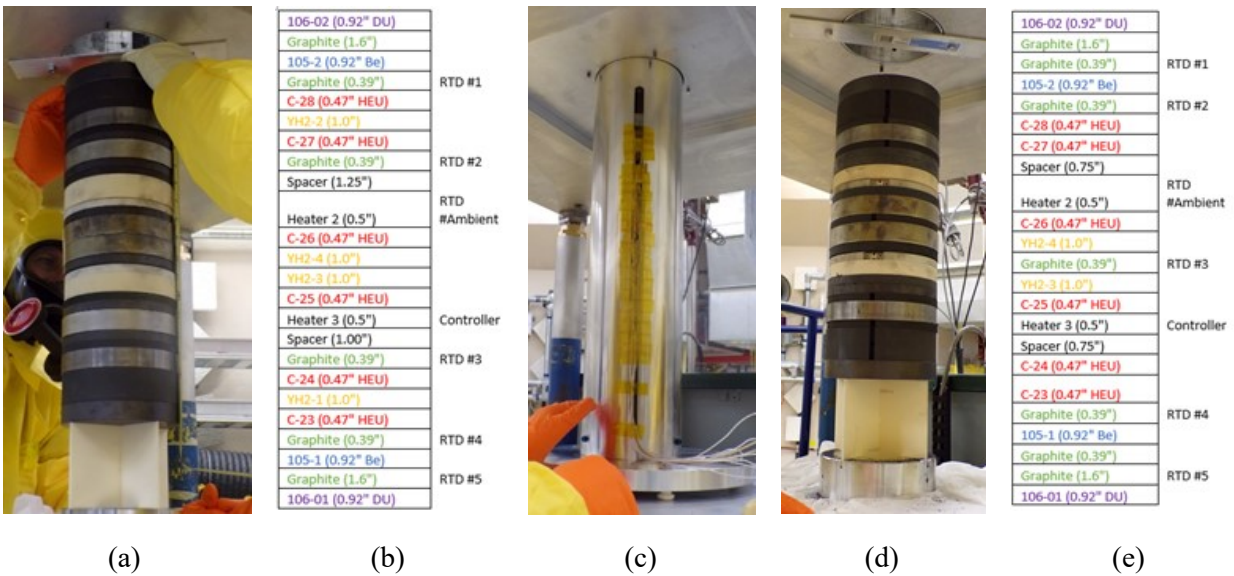

Figure 24. Hypatia column pictures and diagrams: (a) Configuration 1 picture; (b) Configuration 1 diagram; (c) fuel column with guide tube and heater and resistance-temperature-detector wires in place; (d) Configuration 3 picture; and (e) Configuration 2 diagram.



Figure 25. Full Hypatia Experiment setup on the Planet critical assembly machine at NCERC.

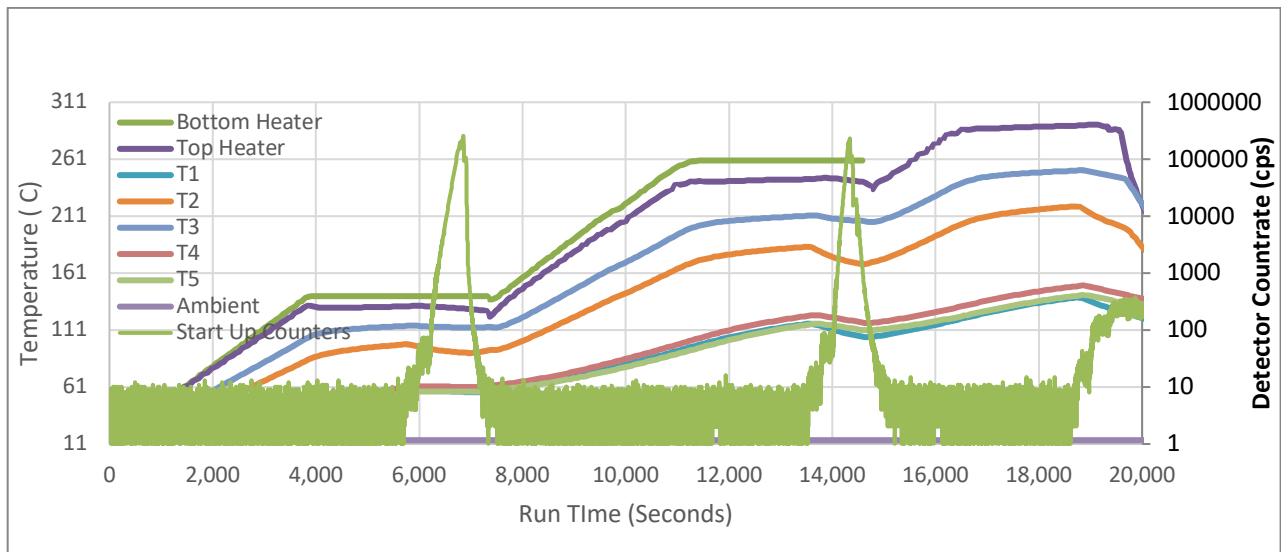

Figure 26. Hypatia Configuration 1 temperature and neutron power profile as a function of run time.

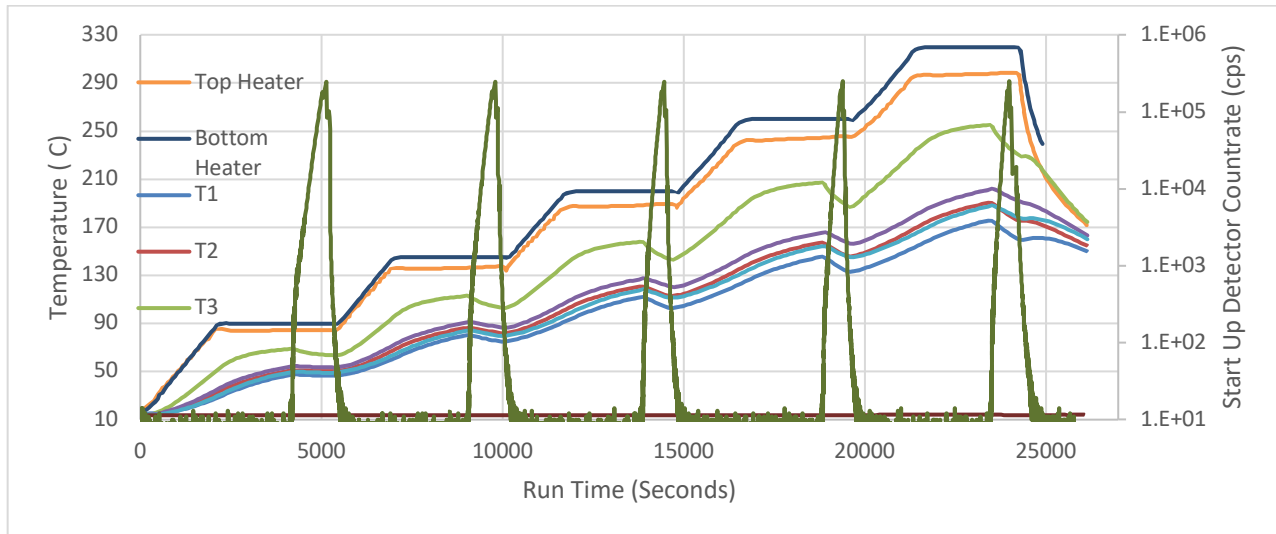

Figure 27. Hypatia Configuration 21 temperature and neutron power profile as a function of run time.

NCERC is supported by the DOE Nuclear Criticality Safety Program, funded, and managed by the National Nuclear Security Administration for DOE.

5. MARVEL AND APPLICATIONS INTEGRATION TESTING

Under the auspices of the DOE Microreactor Program, INL is developing a nuclear microreactor applications test bed at INL, called MARVEL, to perform R&D on various operational features of microreactors to improve integration of microreactors with end-user applications.

Through collaboration between the DOE Microreactor Program and the National Reactor Innovation Center, development of the MARVEL test bed provides an opportunity to establish and exercise the Center's key capabilities to support future reactor demonstrations by addressing:

- The need identified in engagements with potential end users of microreactor systems that want more information about how microreactors meet their application needs
- Development of a small-scale reactor for R&D purposes for the first time in 40 years
- Engagement with and outreach to end users and stakeholders to perform R&D on the integration of microreactors with a range of anticipated applications, such as load-following electricity demand, process heating, hydrogen production, and water purification
- R&D to investigate and address issues and challenges related to the fabrication, assembly, rapid installation, and deployment and operation of microreactors to facilitate end-user adoption.

MARVEL will be installed and operated at INL's TREAT facility, as shown in Figure 28. MARVEL will encompass a 100-kWth fission reactor, based on an existing design and technology (from SNAP-10A) that can be designed, fabricated, and started up within approximately 2 years. The reactor will be cooled by sodium potassium eutectic, with natural-circulation cooling and an operating temperature of 500–550°C. Power conversion will be via existing technology Stirling engines. The reactor core life is anticipated to be 2 years. Detailed neutronics evaluations have been completed for several core and reflector geometries.



Figure 28. MARVEL reactor at INL's TREAT facility.

5.1 Planned Capabilities

The nuclear microreactor applications test bed extends capabilities beyond those of MAGNET to provide a nuclear test platform that includes a full physics system that represents actual operational features of a microreactor, including nuclear behavior for application demonstrations. Lessons learned and experience gained with component testing and instrumentation control from MAGNET testing will ensure accelerated demonstration with MARVEL. The combination of MAGNET and the nuclear microreactor test bed provides unique capabilities to support industry in accelerating development, testing, demonstration, and qualification of key microreactor technologies.

MARVEL will test, demonstrate, and address issues to achieve:

- Normal operating transients, such as startup and load management
- Reactor-safety maintenance
- Cyber- and physical-security hardening.

MARVEL will enable remote monitoring by:

- Demonstrating radiation and temperature-hardened sensors and instrumentation for live data acquisition from the reactor and wireless transmission to a remote monitoring location. The test bed can also perform sensor reliability and qualification tests.
- Demonstrating wireless transmission of live data of both electrical- and thermal-power output during startup, operation, and shutdown. This allows real-time feedback on system output, performance, and prediction of any unplanned maintenance needed in an operating microreactor.

MARVEL will also perform application integration and control:

- The control systems manage grid demand and reactor power supply. This management requires a carefully designed control system that can predict the interplay of controls, thermal inertia, and reactivity feedback.
- The test bed will demonstrate integration approaches for a range of applications, investigating both reactor power management and load management approaches.

6. MICROREACTOR PROGRAM SUPPORTED EXPERIMENT CAPABILITIES AT UNIVERSITIES

This section provides a brief overview of the current funded research at universities through DOE's Nuclear Energy University Program (NEUP), in support of development of microreactors.

6.1 Demonstrating Reactor Autonomous Control Framework Using Graphite Exponential Pile

Project Participants: PI: Dr. Bren Phillips (Massachusetts Institute of Technology [MIT])

Objectives:

Innovation is necessary in both construction and operation if small modular reactors and microreactors are to be financially attractive. For operation, one focus area is the development of fully autonomous reactor control. However, significant efforts will be required to demonstrate an autonomous control framework for a nuclear system while adhering to established safety criteria. For critical reactors, these criteria preclude implementing such a framework. At MIT, recent efforts to restart a subcritical graphite pile have provided an innovative opportunity to develop and demonstrate autonomous control. Due to the inherently safe characteristics of the graphite pile, experiment design is less constrained. Thus, we are constructing an in-pile experimental test bed that will facilitate demonstration of an autonomous control system, as shown in Figure 29. The control system will incorporate state-of-the-art neural-network libraries. The overall objective is to provide an experimental evaluation of nuclear artificial intelligence machine-learning control over a subcritical system.

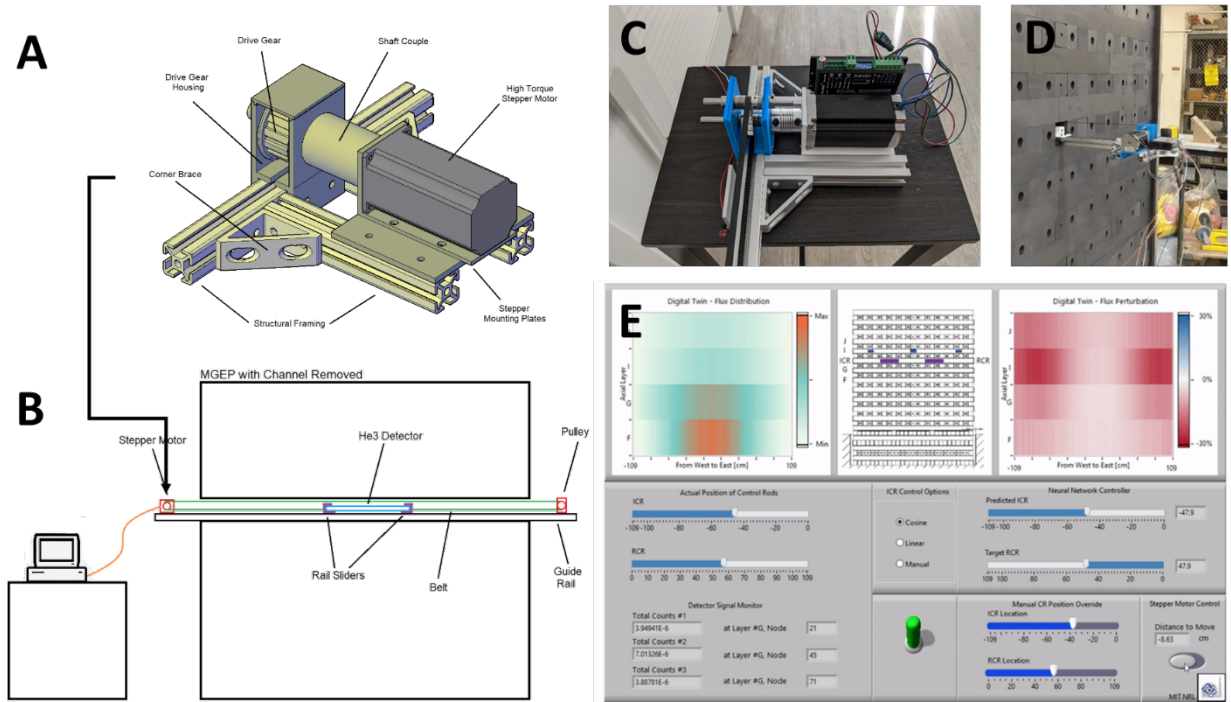

Figure 29. Overview of project progress. (A) Final 3D computer-aided drawing of the pulley assembly used to precisely control in-pile detectors and the movement of control rods. (B) Simplified schematic of plans for the in-pile facility. (C) Actual picture of the 3D-printed assembly. (D) Picture of pulley assembly installed within the graphite pile. (E) Screen shot of control system graphical user interface that has multiple neural nets embedded in the backend.

6.2 Determining the Effects of Neutron Irradiation on the Structural Integrity of Additively Manufactured Heat Exchangers for Very Small Modular Reactor Applications

Project Participants: PI: Prof. Bart Prorok (PI, Auburn University); Prof. Scott Thompson (Co-PI, Kansas State University); Prof. John Gahl (Co-PI, University of Missouri)

Objectives:

This project aims to better understand how neutron irradiation, heat treatment, and build orientation affect the microstructure and mechanical properties of various additively manufactured (via laser powder-bed fusion) nickel-based superalloys to the very small modular reactor (vSMR) industry. Fully dense specimens will be neutron (and ion) irradiated using facilities at the University of Missouri Research Reactor. Precipitate phases and microstructure in various nickel-based superalloys will be varied via heat treatment to determine effects of irradiation on microstructure. Microstructure images and hardness measurements will be collected before and after irradiation. All results will be compared with wrought samples undergoing the same conditions. Results will aid in the design and additive manufacture of high-temperature, nickel-based heat exchangers that are more irradiation tolerant.

6.3 Experiments for Modeling and Validation of Liquid-Metal Heat-Pipe Simulation Tools for Microreactors

Project Participants: PI: Prof. Yassin Hassan, Texas A&M University (TAMU).

Collaborators: Dr. Rodolfo Vaghetto, TAMU; Dr. Mark Anderson, the University of Wisconsin–Madison (UWM); INL, and LANL.

Objectives:

The proposed work aims to produce high-fidelity liquid-metal heat-pipe experimental data for the validation of the simulation tool, Sockeye, through both single heat-pipe and integrated heat-pipe experiments. In accordance with this objective, the following three categories of heat-pipe experimental data will be generated as the main deliverables.

1. Wick characteristics, including capillary rise, wall friction, and pressure-drop form factor
2. Single liquid-metal heat-pipe pressure, temperature, and phase-distribution data
3. Multiple liquid-metal heat pipes (for integrated system performance): experimental database under various operational scenarios.

The proposed experimental activities will be conducted by TAMU and UWM. The single heat-pipe experiments are designed to measure thermal-hydraulic parameters “inside a heat-pipe” in various operational modes so that the data can be directly used for validation and development of closure models. Integrated heat-pipe experiments will be performed to investigate the performance of a multiple heat-pipe system in various test scenarios and to provide associated validation data.

6.4 Experiments and Computations to Address the Safety Case of Heat-Pipe Failures in Special Purpose Reactors

Project Participants: PI: Dr. Victor Petrov and Prof. Annalisa Manera, University of Michigan

Objectives:

This project focuses on heat-pipe microreactors, particularly on reactors using liquid-metal-based heat pipes. Current gaps that have been identified include: (1) the lack of detailed experimental data on heat-pipe behavior during operational and abnormal transient scenarios; and (2) the lack of adequate knowledge about

the possibility of cascading failure of several heat pipes. The work focuses on addressing these gaps through high-fidelity experiments, including high-resolution radiation-based imaging. The plan is to perform high-resolution, highly accurate temperature measurements on a pipe's outside surface using high-accuracy small size TCs and fiber-optic temperature sensors (if needed) to obtain data on internal heat-pipe behavior, such as the evolution of liquid-vapor interface and wick structure saturation during startup, shutdown, and normal operation. Measurements will be conducted at different heat-pipe inclinations and different heating powers. The minicore (comprising multiple heat pipes) measurements will be performed using various temperature sensors to obtain high-fidelity temperature data in normal operation and single or multiple heat-pipe failure scenarios:

- Task 1. Scaling study and pretest simulations for the design of the experimental facility
- Task 2. Construction of the experimental facility
- Task 3. Definition and execution of experimental campaign
- Task 4. Performance of experimental data analysis aimed at improving and validating MOOSE models (specifically, of Sockeye code within MOOSE code suite)
- Task 5. Recommendations for a heat-pipe microreactor safety case.

Capabilities of the Experimental and Computational Multiphase Flow Laboratory include:

- High-resolution, high-speed X-ray radiography and tomography system capable of acquiring images at the frame rate of up to 1000 fps
- High-resolution gamma-tomography system
- Machinery for the imaging system positioning with an aperture up to 1.4 m
- Laser-based system for distributed temperature sensing with the capability to manufacture in-house optic-fiber sensors
- Data acquisition systems, based on field-programmable gate array with the real-time operating system
- Expertise in developing high-temperature experimental facilities for material-study applications with a precise temperature gradient (withing 0.1°) and exposition time of up to 900 hr.

7. CONCLUSIONS

In conclusion, this document provides a summary of the experimental capabilities and activities developed and currently performed under DOE's Microreactor Program. The document will be updated as necessary when new microreactor technologies are identified and developed.

8. REFERENCES

- Bao, S., Y. Wang, and L. Liu. "An error elimination method for high-temperature digital image correlation using color speckle and camera," *Optics and Lasers in Engineering* 116, 2019: 47–54. [10.1016/j.optlaseng.2018.12.011](https://doi.org/10.1016/j.optlaseng.2018.12.011).
- Baranwal, R., "DOE-NE Strategic Vision, U.S. Department of Energy, Office of Nuclear Energy," <https://www.energy.gov/sites/prod/files/2021/01/f82/DOE-NE%20Strategic%20Vision%20-Web%20-%2001.08.2021.pdf>. 2021. Accessed February 15, 2021.
- Berke, R., and J. Lambros. "Ultraviolet digital image correlation (UV-DIC) for high temperature applications," *Review of Scientific Instruments* 85, 2014:1–9. [10.1063/1.4871991](https://doi.org/10.1063/1.4871991).
- Capstone Turbine Corporation, <https://www.capstoneturbine.com/products/c30>. Accessed August 5, 2020.
- Daw, J., "Development of Ultrasonic Thermometer at INL," *Nuclear Science User Facilities 2018 Annual Report*, 2018: 66-75.

- Gorjup, D., J. Slavič, and M. Boltežar, “speckle_pattern,” https://github.com/ladisk/speckle_pattern. Accessed March 18, 2021.
- Grant, B., H. Stone, P. Withers, and M. Preuss. “High-temperature strain field measurement using digital image correlation,” *Journal of Strain Analysis for Engineering Design* 44, 2009: 263–271. [10.1243/03093247JSA478](https://doi.org/10.1243/03093247JSA478).
- Guillen, D.P., L.R. Greenwood, and J.R. Parry. “High conduction neutron absorber to simulate fast reactor environment in an existing test reactor,” *Journal of Radioanalytical and Nuclear Chemistry* 302 (1), 2014: 413–424. [10.1007/s10967-014-3251-6](https://doi.org/10.1007/s10967-014-3251-6).
- Guillen, D.P. and D.S. Wendt, (2020) *Integration of a Microturbine Power Conversion Unit in MAGNET: Analysis of a Power Conversion Unit (PCU) for the Microreactor Agile Non-nuclear Experimental Test bed (MAGNET)*, Idaho National Laboratory report INL/EXT-20-57712, Idaho Falls, ID, USA, 2020.
- Guillen D.P. and D.S. Wendt, “Technical Feasibility of Integrating A Modified Power Conversion Unit into a Non-Nuclear Microreactor Test bed,” *International Journal of Energy Research*, 2021. <https://doi.org/10.1002/er.6517>.
- Guillen, D.P. *Alternative Heat Removal Technologies for Microreactors, Novel Thermal Management Strategies for Nuclear Microreactors*, Idaho National Laboratory report INL/EXT-20-57711, Idaho Falls, ID, USA, 2021.
- Hao, W., J. Zhu, Q. Zhu, L. Chen, and L. Li. “Displacement field denoising for high-temperature digital image correlation using principal component analysis,” *Mechanics of Advanced Materials and Structures* 24, 2017: 830–839. [10.1080/15376494.2016.1196787](https://doi.org/10.1080/15376494.2016.1196787).
- Hehr, A., et al. “Five-Axis Ultrasonic Additive Manufacturing for Nuclear Component Manufacture,” *Journal of The Minerals, Metals & Materials Society* 69 2017: 485–490. [10.1007/s11837-016-2205-6](https://doi.org/10.1007/s11837-016-2205-6).
- Leplay, P., O. Lafforgue, and F. Hild. “Analysis of asymmetrical creep of a ceramic at 1350 C by digital image correlation,” *Journal of the American Ceramics Society* 98, 2015: 2240–2247. [10.1111/jace.13601](https://doi.org/10.1111/jace.13601).
- Lyons, J.S., J. Liu, and M.A. Sutton, “High-temperature Deformation Measurements Using Digital-image Correlation,” *Experimental Mechanics* 36, 1996: 64–70.
- Ma, C., Z. Zeng, H. Zhang, and X. Rui. “A Correction Method for Heat Wave Distortion in Digital Image Correlation Measurements Based on Background-Oriented Schlieren,” *Applied Sciences* 9, 2019: 1–17. [10.3390/app9183851](https://doi.org/10.3390/app9183851).
- McCary, K.M. *Evaluation of Fiber Bragg Grating and Distributed Optical Fiber Temperature Sensors*, Idaho National Laboratory report INL/EXT-17-41728, Idaho Falls, ID, USA, 2017.
- Morton, T.J. *Microreactor Agile Non-Nuclear Experimental Test Bed (MAGNET) Startup*, Idaho National Laboratory report INL/EXT-20-61197, Idaho Falls, ID, USA, 2020.
- Novak, M., and F. W. Zok. “High-temperature materials testing with full-field strain measurement: experimental design and practice,” *Review of Scientific Instruments* 82, 2011: 1–6. [10.1063/1.3657835](https://doi.org/10.1063/1.3657835).
- Pan, B., D. Wu, Z. Wang, and Y. Xia. “High-temperature digital image correlation method for full-field deformation measurement at 1200 C,” *Measurement Science and Technology* 22, 2011: 1–11. [10.1088/0957-0233/22/1/015701](https://doi.org/10.1088/0957-0233/22/1/015701).
- Petrie, C.M., et al. “Embedded metallized optical fibers for high temperature applications,” *Smart Materials and Structures* 28 2019a: 055012. [10.1088/1361-665X/ab0b4e](https://doi.org/10.1088/1361-665X/ab0b4e).

- Petrie, C.M., et al. "High-temperature strain monitoring of stainless-steel using fiber optics embedded in ultrasonically consolidated nickel layers," *Smart Materials and Structures* 28, 2019b: 085041. [10.1088/1361-665X/ab2a27](https://doi.org/10.1088/1361-665X/ab2a27).
- Petrie, C.M., and N. D. B. Ezell. *Demonstrate embedding of sensors in a relevant microreactor component*, Oak Ridge National Laboratory report ORNL/SPR-2020/1742, Oak Ridge, TN, USA, 2020a. <https://doi.org/10.2172/1720216>.
- Petrie, C.M. and N. Sridharan. "In situ measurement of phase transformations and residual stress evolution during welding using spatially distributed fiber-optic strain sensors," *Measurement Science and Technology* 31 2020b: 125602. [10.1088/1361-6501/aba569](https://doi.org/10.1088/1361-6501/aba569).
- Sabharwall, P., J. Hartvigsen, T. Morton, Z. Sellers, and J.S. Yoo. *SPHERE Assembly and Operation Demonstration*, Idaho National Laboratory report INL/EXT-20-60782, Idaho Falls, ID, USA, 2020.
- Sharma, S., G. Ko and K. Kang. "High temperature creep and tensile properties of alumina formed on ferroalloy foils doped with yttrium," *Journal of the European Ceramics Society* 29, 2009: 355–362. [10.1016/j.jeurceramsoc.2008.05.051](https://doi.org/10.1016/j.jeurceramsoc.2008.05.051).
- Skifton, R.S., J. Palmer, K.L. Davis, P. Calderoni, D. Corbett, and E. Sikorski. "Summary of High Temperature Irradiation Resistant Thermocouple Standardization Tests," Idaho National Laboratory report INL/CON-18-51789, Idaho Falls, ID, USA, 2018.
- Su, Y., X. Yao, S. Wang and Y. Ma. "Improvement on measurement accuracy of high-temperature DIC by grayscale-average technique," *Optics and Lasers in Engineering* 75, 2015: 10–16. [10.1016/j.optlaseng.2015.06.003](https://doi.org/10.1016/j.optlaseng.2015.06.003).
- Sweeney, D.C., A.M. Schrell, and C.M. Petrie. "An Adaptive Reference Scheme to Extend the Functional Range of Optical Backscatter Reflectometry in Extreme Environments," *IEEE Sensors Journal* 21, 2020: 498–509. [10.1109/JSEN.2020.3013121](https://doi.org/10.1109/JSEN.2020.3013121).
- Trellue, H., J. O'Brien, R. Reid, D. Guillen, and P. Sabharwall. *Microreactor Agile Nonnuclear Experiment Test bed Test Plan*, LA-UR-20-20824, 2019.
- U.S. Advanced Nuclear Energy Strategy for Domestic Prosperity, Climate Protection, National Security, and Global Leadership*, Nuclear Innovation Alliance, Partnership for Global Security, February 2021.
- Wood, T.W., et al. "Evaluation of the Performance of Distributed Temperature Measurements with Single-Mode Fiber Using Rayleigh Backscatter up to 1000°C," *IEEE Sensors Journal* 14, 2014: 124–128. [10.1109/JSEN.2013.2280797](https://doi.org/10.1109/JSEN.2013.2280797).
- Wright, S.A., R.J. Lipinski, M.E. Vernon, and T. Sanchez. "Closed Brayton Cycle Power Conversion Systems for Nuclear Reactors: Modeling, Operations, and Validation," Sandia National Laboratories report SAND2006-2518, Albuquerque, NM, USA, 2006. [10.2172/1177051](https://doi.org/10.2172/1177051).