

HALEU Decontamination Investigations for EBR-II Recovered Uranium

Michael N. Patterson
Brian R. Westphal
David D. Tolman
J. C. Price

March 2019

The INL is a
U.S. Department of Energy
National Laboratory
operated by
Battelle Energy Alliance

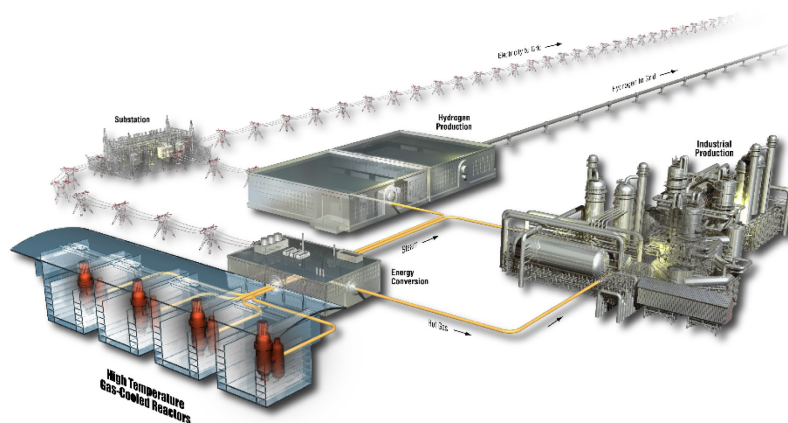

DISCLAIMER

This information was prepared as an account of work sponsored by an agency of the U.S. Government. Neither the U.S. Government nor any agency thereof, nor any of their employees, makes any warranty, expressed or implied, or assumes any legal liability or responsibility for the accuracy, completeness, or usefulness, of any information, apparatus, product, or process disclosed, or represents that its use would not infringe privately owned rights. References herein to any specific commercial product, process, or service by trade name, trade mark, manufacturer, or otherwise, does not necessarily constitute or imply its endorsement, recommendation, or favoring by the U.S. Government or any agency thereof. The views and opinions of authors expressed herein do not necessarily state or reflect those of the U.S. Government or any agency thereof.

HALEU Decontamination Investigations for EBR-II Recovered Uranium

**Michael N. Patterson
Brian R. Westphal
David D. Tolman
J. C. Price**

March 2019

**Idaho National Laboratory
INL ART Program
Idaho Falls, Idaho 83415**

<http://www.art.gov>

**Prepared for the
U.S. Department of Energy
Office of Nuclear Energy
Under DOE Idaho Operations Office
Contract DE-AC07-05ID14517**

INL ART Program

HALEU Decontamination Investigations for EBR-II
Recovered Uranium

INL/EXT-19-53191
Revision 0

March 2019

Technical Reviewer: (Confirmation of mathematical accuracy, and correctness of data and appropriateness of assumptions.)

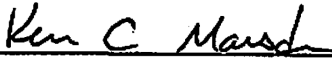

Ken C. Marsden
Department Manager of Pyrochemistry & Molten Salt
Systems



Date

Approved by:

 for SBS

Shannon M. Bragg-Sitton
Department Manager, Systems Integration



Date

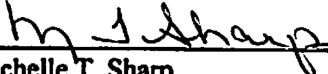

Michelle T. Sharp
INL Quality Assurance

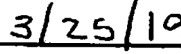

Date

EXECUTIVE SUMMARY

Uranium recovered from the conditioning of irradiated EBR-II driver fuel has been recognized as a potential source of feedstock for advanced reactor concepts utilizing fuel designs with enrichments between 5 and 20 % U-235, also known as high assay low enriched uranium. INL has recently conducted research into a process enhancement intended to reduce the quantity of fission product contaminants associated with this material to help facilitate its use in HALEU fuels. The research involved a revised molten metal casting configuration employing a drip casting technique in conjunction with a two part graphite crucible with the goal of separating the majority of the casting slag from the uranium metal while also reducing the physical size of the resulting ingot. Casting trials conducted as part of this research have successfully demonstrated drip casting into approximately 3 kg uranium pieces which show a reduction in dose rate of approximately a factor of 200 from the large original uranium ingots. These developments provide a viable route for HALEU feedstock from processed EBR-II material.

CONTENTS

EXECUTIVE SUMMARY	vii
ACRONYMS.....	xi
1. INTRODUCTION.....	1
2. BACKGROUND.....	1
3. EXPERIMENTAL	3
4. CONCLUSION AND RECOMMENDATIONS	9
5. REFERENCES.....	10

FIGURES

Figure 1. Traditional uranium ingot produced from EMT operations.	2
Figure 2. Photograph of the reusable graphite crucible system.	2
Figure 3. Overview of small scale drip cast test.	4
Figure 4. Cross-section of the assembled two-piece graphite crucible for drip casting uranium products.	5
Figure 5. Two piece graphite crucible for drip casting with the lower (a) and upper (b) pieces.	5
Figure 6. Ingot form (a) and regulus form (b) for uranium products produced in FCF.....	6
Figure 7. CPDC001 photographs of slag in upper crucible (a) and reguli in lower crucible (b).	7
Figure 8. CPDC002 photographs of top of the lower crucible with reguli (a) and reguli removed (b).	8
Figure 9. Containers in FCF used to store either slag and reguli (a) or a single regulus (b).....	8
Figure 10 Uranium product storage container.	9

TABLES

Table 1 Relevant data for the two drip-cast experiments in FCF with EBR-II driver uranium products.	6
Table 2. Radiation readings of slag, reguli, and regulus from CPDC001 and CPDC002 experiments.....	9

ACRONYMS

CFFS019	Casting Furnace Fissium Fuel Batch #19
CPDC001	Cathode Processor Drip Cast
DOE	Department of Energy
DRC	driver regulus container
EBR	Experimental Breeder Reactor
EMT	electrometallurgical treatment
FASB	Fuels and Applied Science Building
FCF	Fuel Conditioning Facility
FCG	fuel cycle glovebox
HALEU	high assay low enriched uranium
HUP	high-throughput uranium product
INL	Idaho National Laboratory
MFC	Materials and Fuels Complex
MT	metric tons
UPS	uranium product storage

HALEU Drip Casting Results in the Fuel Conditioning Facility Cathode Processor

1. INTRODUCTION

Many of the new advanced reactor designs being proposed by the nuclear private sector require uranium fuel enriched between 5 and 20%, otherwise known as high assay low enriched uranium (HALEU) [1], to support their designs. There are currently no commercial facilities based in the United States which have the capability to produce this material. As a result, the nuclear industry has requested support from the Department of Energy (DOE) to meet this need. One approach being considered by DOE to respond to this demand is to recover highly enriched uranium from used nuclear fuels and downblend it to enrichments less than 20% U-235. DOE's past research related to liquid metal fast breeder reactors resulted in the irradiation of more than 3 metric tons (MTs) of nuclear fuel composed of highly enriched metallic uranium which resides at the Idaho National Laboratory (INL). This inventory of used nuclear fuel is currently being conditioned using an electrometallurgical treatment (EMT) process. As part of this treatment process, the highly enriched component of this used fuel is separated, recovered, downblended to <20% U-235, and stored as a metallic uranium ingot.

The majority of this fuel was irradiated in the Experimental Breeder Reactor II (EBR-II) over the course of 30 years of operation. This sodium cooled fast reactor utilized a core comprised of highly enriched, sodium-bonded, metallic fuel to sustain or "drive" the reactor. This EBR-II driver fuel is currently being treated for sodium neutralization in the Fuel Conditioning Facility (FCF) at the Materials and Fuels Complex (MFC), and the metallic uranium recovered as a component of this process has been proposed as a potential source for supply of HALEU.

The irradiation of metallic uranium fuel results in the creation of fission products and some minor actinides which are not compatible with many reuse scenarios and that introduce significant challenges associated with fabrication of new fuel elements using this material. However, it is believed that the current EMT process can be slightly enhanced to address these concerns and result in the recovery of a product that can be an eligible source of supply for HALEU applications. Based on this, DOE requested the INL to research methods to enhance the EMT process to produce a recovered uranium material that has a lower contaminant level and lower radiological dose rate and could be utilized in glovebox-based fuel-fabrication scenarios. This report documents the progress toward meeting this goal.

2. BACKGROUND

As a result of EBR-II driver fuel treatment, a total of 3.86 MT of potential HALEU feedstock has been generated. With an additional 6 MT anticipated to be produced from ongoing treatment operations, the resulting total will be approximately 10 MT of potential HALEU feedstock. The traditional ingot produced from the EMT process (see Figure 1) has an approximate diameter of 20 cm, a thickness between 2 to 9 cm and a mass ranging from 11 to 50 kg. Size and shape were selected to facilitate efficient storage of the recovered material under an assumption that future reuse scenarios would involve handling the material within a hot cell. Based on this assumption, the radiological dose rate and the large mass of the ingots were not a concern during the early development of the treatment program. However, as disposition of the recovered uranium material gained more interest, the ingots' high dose rate, large mass, and level of transuranic impurities were identified as unfavorable characteristics of the material. Limited investigations previously initiated to explore methods capable of addressing these undesirable traits suggested that production of a uranium ingot with reduced size and radiological dose rate could help facilitate disposition. This early research also suggested that reheating and recasting the recovered uranium product could result in significant reductions in radiological dose rate [2]. The size and scope of these investigations were accelerated in 2018 based on DOE interest in the potential reuse of recovered EBR-II uranium as feedstock for HALEU fuel fabrication. The foundation of the accelerated research was

based on integrating a gravity-based drip-cast methodology into the existing process and led to the development of a reusable graphite-crucible system (Figure 2) that could be accommodated in the FCF cathode processor. Recently, two experiments were performed in FCF using the cathode processor to evaluate the efficacy of size and dose reduction via this drip-cast, two-piece graphite crucible.



Figure 1. Traditional uranium ingot produced from EMT operations.



Figure 2. Photograph of the reusable graphite crucible system.

Prior to the two most-recent experiments, research consisted of using various furnaces in conjunction with different uranium compositions to develop crucible materials and designs capable of delivering the desired outcomes. Initial research was performed in the Fuels and Applied Science Building (FASB) using a 10-inch-diameter furnace to test a crucible concept having multiple pockets and lined with a zirconia castable refractory material. This test was intended to demonstrate the feasibility of using the casted liner and the ability of the uranium to release from multiple pockets. Natural uranium rods were melted into an ingot shape, and the resulting ingot was placed into the multiple-pocket crucible and reheated. Transformation from the ingot shape to smaller uranium slugs, termed “reguli (plural) or regulus (singular),” was successfully demonstrated, along with the release of uranium from the crucible, although some bridging between pockets was observed. The bridging was expected, given the initial placement of the uranium directly on the top surface of the pockets. This concept was increased in scale and deployed in the FCF casting furnace to evaluate the degree to which the radiological dose rate could be reduced via ingot recasting and transformation from a large uranium ingot to multiple small reguli. The results of this test were encouraging with regard to dose-rate reduction; however, the bridging of the uranium between pockets remained. This led to the development of a stackable, two-piece crucible arrangement that

allowed molten uranium to drip through the top crucible into multiple cascading pockets, forming uranium reguli. Unfortunately, the vertical limitations in the FCF casting furnace would not allow sufficient melting of the uranium and, thus, flow into the reguli pockets. At this point, it was decided to utilize the FCF cathode processor for drip casting due to its increased stacking capability within the hot zone of the furnace.

As a precursor to deployment of the large-scale two-piece drip stack crucible in the cathode processor, several design features for the stackable crucibles were in need of refinement, leading to the development of a small-scale test planned for execution in the distillation furnace of the FCF fuel cycle glovebox (FCG). The purpose of testing in the FCG was to demonstrate that yttria-coated graphite crucibles could be utilized instead of graphite crucibles lined with casted zirconia refractory material, and to establish drain-hole and spillover-channel dimensions in a two-piece crucible arrangement. This test utilized a reduced-diameter two-part crucible, but still retained the capability to validate pocket depth and angle, as well as the ability to flow molten uranium between the interconnected pockets to reduce the bridging tendency observed in the earlier regulus test. Heavily oxidized natural-uranium rods were selected for the small-scale test and were first consolidated into an ingot. The resulting ingot was then placed into the upper-tier crucible in preparation for the drip test. This work is illustrated in the photographs found in Figure 3. The test resulted in the successful transfer of 93% of the metallic uranium from the upper crucible to the lower crucible, with the molten uranium cascading as intended between the 3 pockets. The tests validated that the inclusion of the spillover channels between the pockets addressed the previously observed bridging concern and that the uranium would release from the yttria-coated graphite. Based on the success of the small-scale tests, manufacturing commenced on a full-scale, multi-tier crucible system to be used with the FCF cathode processor that would allow for the recast of the 30 to 40 kg ingots typically produced in the FCF casting furnace.

3. EXPERIMENTAL

Two drip cast experiments have recently been performed in the FCF cathode processor for the purpose of reducing the uranium product form while minimizing radiation associated with the ingot. The ingot form (right circular cylinder approximately 20.3 cm in diameter by 3 to 7 cm tall) produced from the EMT operations in FCF was cast into the regulus form (6.4 cm diameter by 8.9 cm height) using the two-piece crucible shown in Figure 4 and Figure 5. The ingot is placed in the upper section, coated with yttria, and upon melting, molten uranium drips through the 1.3 cm diameter hole to the lower cascading reguli sections which fill from the center outward. A total of twelve reguli can be produced in the yttria coated lower section of the drip cast crucible.

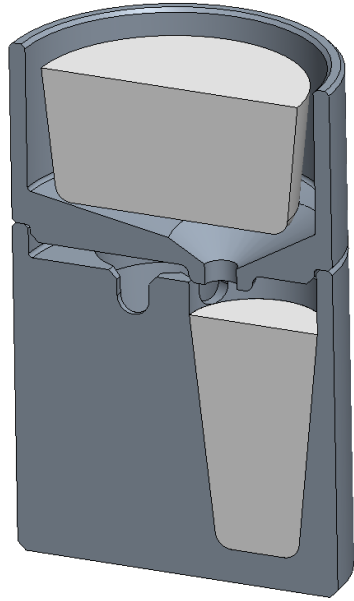

(a) Model of the small scale drip cast crucible system used in the Fuel Cycle Glovebox casting trial.



(b) Small scale drip cast crucible system assembled and loaded with natural uranium ingot prior to forming the regulus.

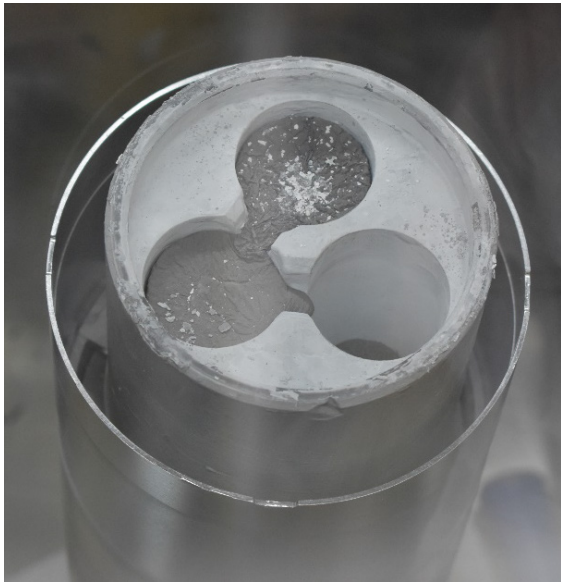

(c) Lower section of the drip cast crucible system after casting of the uranium ingot into the interconnected regulus pockets.



(d) Uranium reguli after removal from the lower crucible.

Figure 3. Overview of small scale drip cast test.

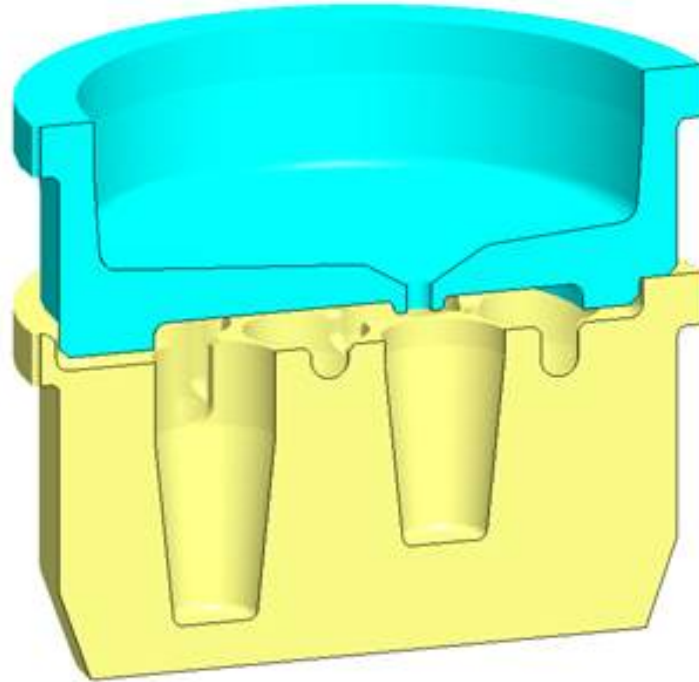

Figure 4. Cross-section of the assembled two-piece graphite crucible for drip casting uranium products.

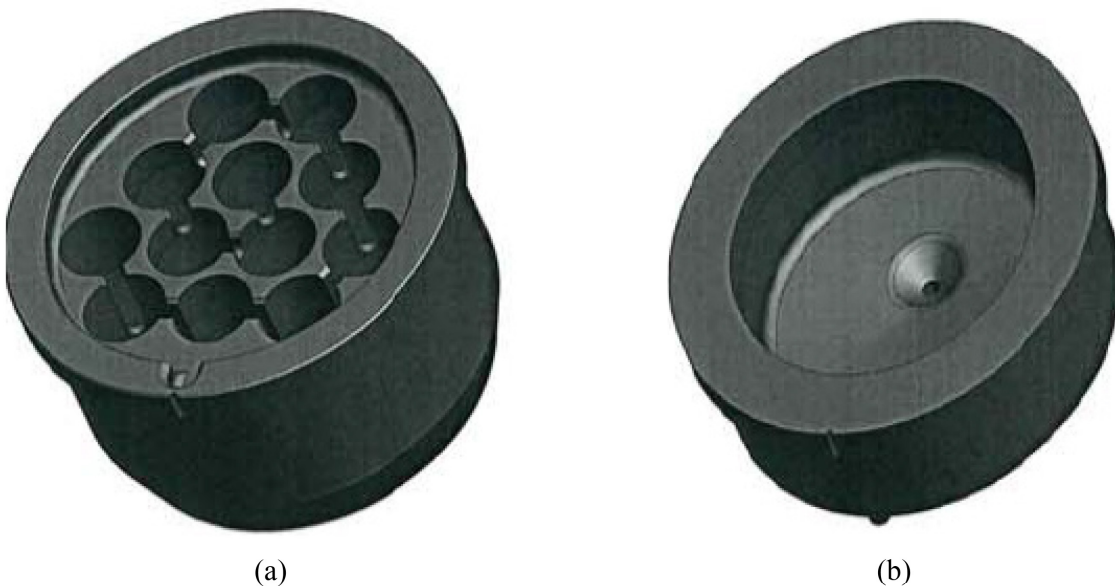

Figure 5. Two piece graphite crucible for drip casting with the lower (a) and upper (b) pieces.

Two traditional driver-uranium product ingots, generated from the processing of fissium fuel in FCF, were selected, based on their relatively high radiation readings following initial casting, see Table 1. The first ingot from Casting Furnace Fissium Fuel Batch 19 (CFFS019) had a mass of 19.8 kg and was renamed Cathode Processor Drip Cast Run 001 (CPDC001), while the second ingot from Casting Furnace Fissium Fuel Batch 20 (CFFS020), weighed 38.1 kg and was renamed CPDC002. The number of reguli pockets filled and the total mass of the reguli is shown in Table 1. The last column of Table 1 is a calculated balance of uranium, primarily the material held up in the upper section of the drip cast crucible.

Figure 6-a contains a photograph illustrating the typical casting furnace ingot, similar to CFFS019 and CFFS020 which were recast into the regulus shape as illustrated in Figure 6-b.

Table 1 Relevant data for the two drip-cast experiments in FCF with EBR-II driver uranium products.

Batch	Mass (kg)	Ingot Radiation Reading (R/hr)	Ingot Cs-137 Content (ppb)	Reguli (#)	Regulus Mass (kg)	Uranium Balance (kg)
CPDCC01	19.8	14.8	1.7	6	18.6	1.2
CPDCC02	38.1	10.0	2.5	11	36.9	1.2

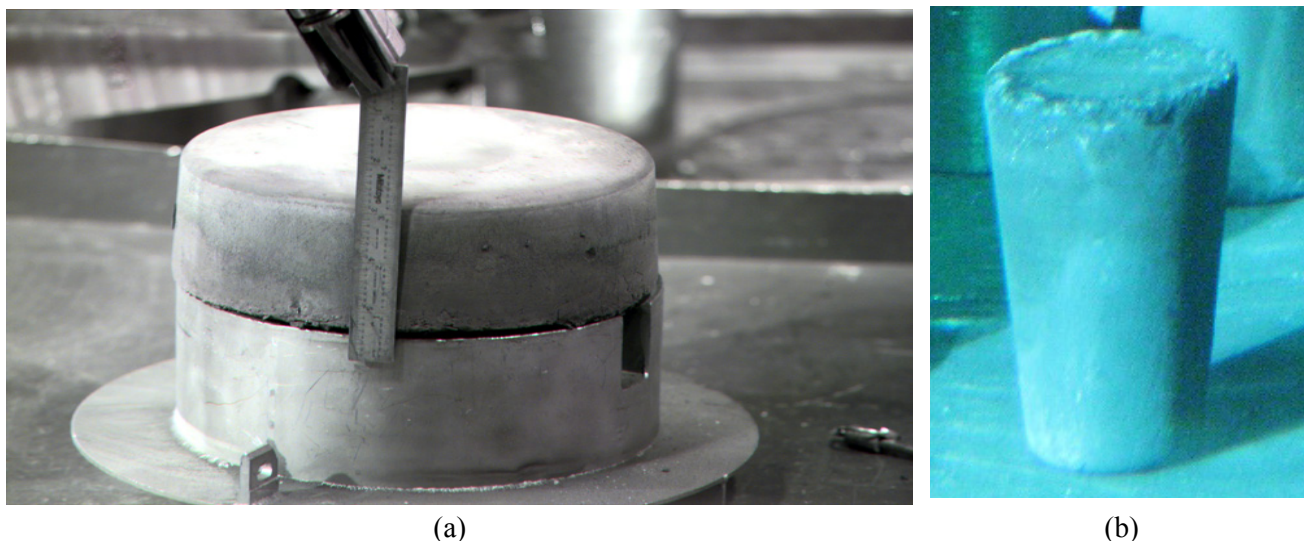
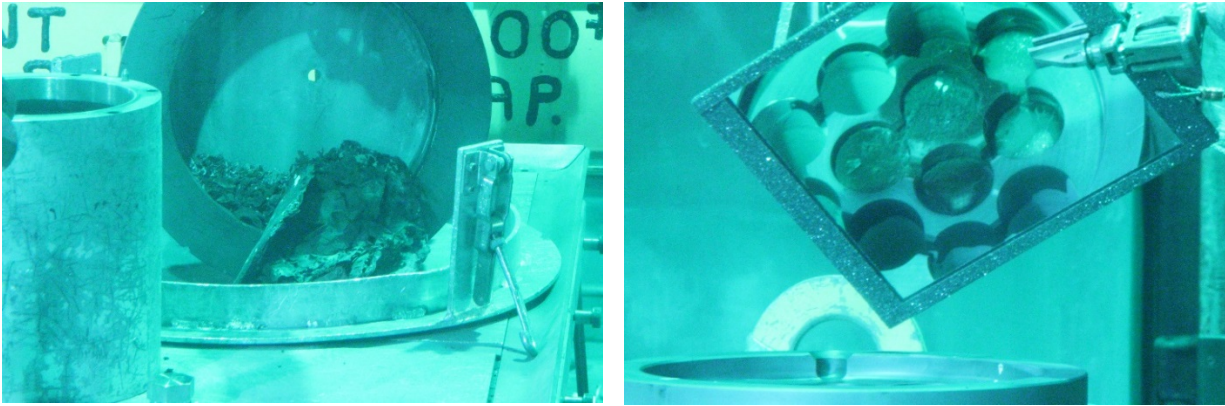

Figure 6. Ingot form (a) and regulus form (b) for uranium products produced in FCF.

Shown in Figure 7 is the slag material remaining in the upper portion of the two-piece crucible (a) and solidified uranium in the first six reguli pockets (b) (Note the image is reflected in the mirror held above the lower crucible). The slag material was primarily friable except for one larger metallic mass in the middle of the crucible near the drain hole. Five complete reguli were filled to approximately 3 kg and one regulus was partially filled. All reguli, except those in Positions 1 and 2, were easily removed from the lower crucible by simply inverting the crucible. A slight amount of bridging between the reguli in Positions 1 and 2 was observed and required the application of a small amount of tensional force to enable them to release from the pockets. Sampling of the slag, Regulus 1, and Regulus 6 was performed for chemical analyses and preliminary results indicate elevated levels of cesium and plutonium in the slag relative to the reguli samples, which suggests a successful separation of the contaminants. Final results for the samples are pending and will be included in future versions of this report.

Photographs of the lower crucible from CPDC002 with reguli still in the pockets (a) and nine of the eleven reguli removed (b) after dumping, are shown in Figure 8. Again, the reguli were easily removed from the lower crucible by inverting the crucible. Samples were taken of the slag material in the upper crucible and from Reguli 1 and 11 for chemical analyses with the results pending.



(a)

(b)

Figure 7. CPDC001 photographs of slag in upper crucible (a) and reguli in lower crucible (b).

Following sampling of the slag and reguli, radiation readings were taken of the slag, individual regulus, and combined reguli, as depicted in Figure 9. Concerns with undesired oxidation forming on the surface of the uranium metal have resulted in the practice of handling the uranium in closed metal containers if the handling is to occur in a non-inert environment. This concern, as well as the need to provide some radiological shielding resulted in the development of two standard containers for handling the traditional 30 to 40 kg uranium ingots, and subsequently a smaller container for handling individual regulus. The uranium product storage (UPS) container, illustrated in Figure 10 and the related high-throughput uranium product (HUP) storage container have traditionally been used to facilitate handling of the ingots while in cell. The containers have also been used for storage of the ingots once they are transferred out of cell and also contain the uranium ingots when researchers collect the dose-rate readings. These containers are also capable of holding either slag material or multiple reguli. The more-recently developed container, the driver regulus container (DRC) in Figure 9[b], holds one individual regulus. Radiation readings were taken from the bottom of both containers. The UPS has a 1.0 cm thick steel plate and the DRC has a 0.4 cm steel plate at the bottom, and the radiation readings are given in Table 2. The radiation reading of 5000 mR/hr for the 1.2 kg of slag separated during the CPDC001 casting trial, indicates a concentration of isotopic contaminants in the isolated slag material when compared to the 1200 mR/hr dose rate for the 18.6 kg of uranium reguli produced. A more significant result was observed during the CPDC002 casting trial. For both casting trials, it appears that the isotopic contaminants residing in the separated slag may be responsible for approximately 50% of the radiological dose rate observed in the original parent ingots. For the reguli, higher radiation was observed for batch CPDC001, even though there is less total mass in the reguli. The cause of this is most likely the slag overflowing into the lower crucible around Regulus 1 and, as a matter of additional note, the radiation reading on Regulus 1 in a DRC was 2200 mR/hr. Regulus 4 for CPDC001 and Regulus 1 for CPDC002 had similar radiation readings, see fourth column of Table 2, further illustrating the impact of the slag carry over to the regulus in position one of the first casting trial. Also of interest is the observation that the radiological dose rate for Regulus 1 in CPDC002 is comparable to the reading obtained for the remaining ten reguli when combined together. Based on these preliminary radiation readings, it appears that the radiological dose rate of potential HALEU from EBR-II in ingot form can be reduced significantly by drip casting into a regulus form.

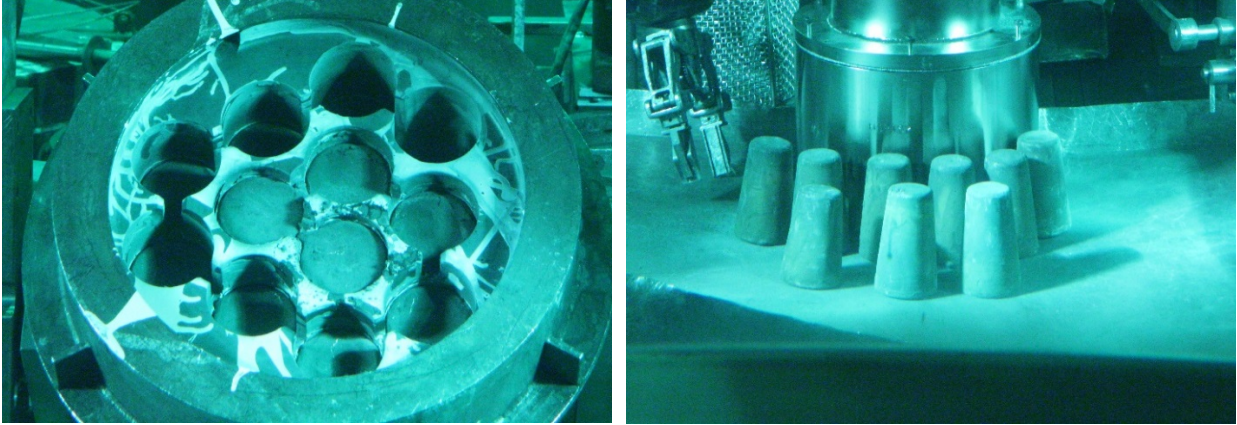

(a)

(b)

Figure 8. CPDC002 photographs of top of the lower crucible with reguli (a) and reguli removed (b).

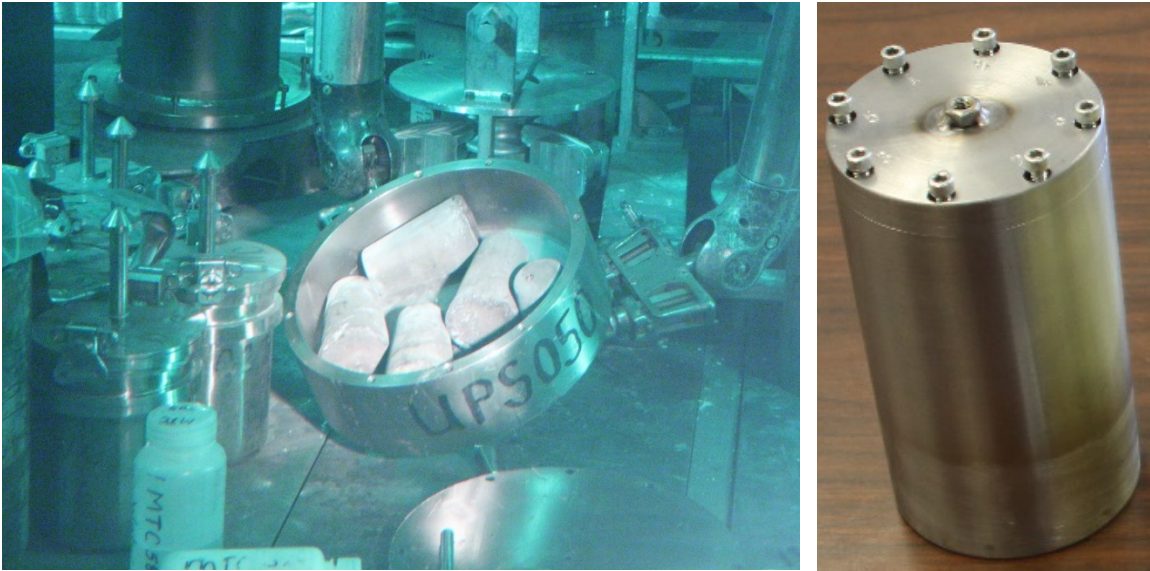

(a)

(b)

Figure 9. Containers in FCF used to store either slag and reguli (a) or a single regulus (b).

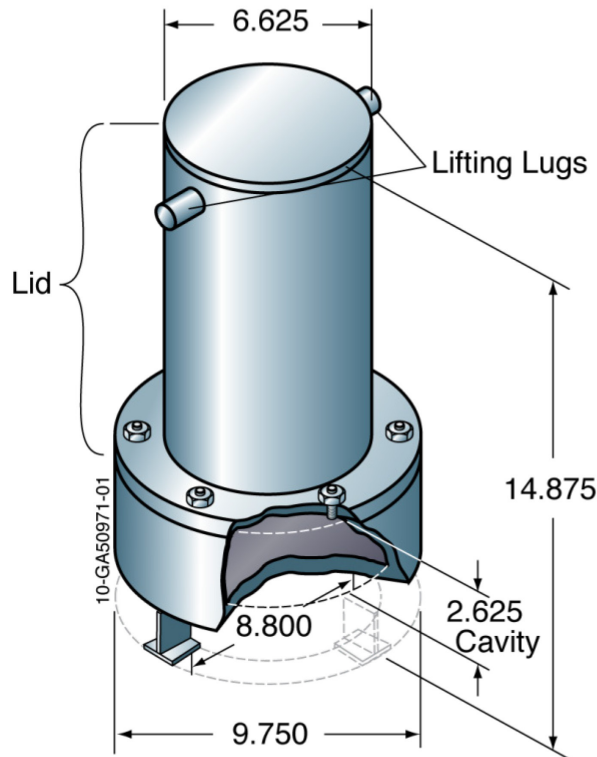

Note: All dimensions in inches

Figure 10 Uranium product storage container.

Table 2. Radiation readings of slag, reguli, and regulus from CPDC001 and CPDC002 experiments.

Batch	Slag (mR/hr)	Combined Reguli (mR/hr)	Individual Regulus (mR/hr)
CPDC001	5000	1200	50
CPDC002	6800	43	43

4. CONCLUSION AND RECOMMENDATIONS

The data collected thus far support the conclusion that drip casting molten uranium using a multi-tier graphite crucible can result in a significant reduction in the original radiological dose rate due to the concentration and separation of the slag from the uranium metal. The two drip casting trials conducted successfully demonstrated the ability to transition the 30 to 40 kg traditional ingot into multiple smaller ingots, referred to as reguli, via a reusable graphite crucible coated with yttria. The smaller physical size, coupled with the significantly reduced radiological dose rate, should enable resulting regulus material to be a candidate to support glovebox-based HALEU-fuel fabrication scenarios. As noted earlier, chemical analysis of multiple samples collected from the casting trials is underway. These results will help to quantify the amount by which the fission-products originally present in the parent ingot were reduced by drip casting into the regulus shape. It is believed that these results will correlate well with the corresponding radiological dose-rate reduction observed through the collection of the radiation readings. The pending chemical analysis should provide insight on whether the drip casting technique has any benefit on reducing the transuranic content of the uranium metal as well.

While, overall, the technique developed has been successful, research is anticipated to continue on further crucible refinements investigating whether a casted zirconia liner can be used at large scale in place of machining multiple pockets into the graphite and then coating each with yttria to facilitate the release of uranium reguli. Originally, this test was intended to demonstrate an ability to increase the enrichment of previously produced ingots that may have less than the desired levels of U-235. However, this upblending operation, which would typically be performed in the FCF casting furnace, was deferred from the current casting trials due to the unavailability of the furnace. Future casting trials are intended to include this step to evaluate upblending requirements.

It is evident that a significant reduction in radiological dose rate has been achieved; however, it is recommended that further radiological characterization be performed on the regulus material once it has been removed from the metal containers. This could require transferring the material to another facility for handling in an inert-atmosphere glovebox or a revision to FCF procedures and equipment to allow for handling of the uranium regulus outside of the metal container.

5. REFERENCES

1. “Final Environmental Assessment for Use of DOE-Owned High-Assay Low-Enriched Uranium Stored at Idaho National Laboratory”, U.S. Department of Energy, Idaho Operations Office, DOE/EA-2087, January 2019.
2. B.R. Westphal, J.C. Price, and M.N. Patterson, “Further Studies on the Recycle of Pyroprocessed Uranium”, *J. Sustain. Met.*, 3 (2017), pp. 690-695. DOI: 10.1007/s40831-017-0126-4.