



ADVANCED
NUCLEAR
REACTOR
TECHNOLOGY

A PRIMER

JULY 2023 UPDATE

ADVANCED NUCLEAR REACTOR TECHNOLOGY

A PRIMER

JULY 2023 UPDATE



nuclearinnovationalliance.org

July 2023

PHOTO CREDITS

Cover:

Gensler architectural design firm, for Third Way

Other images:

Abilene Christian University, ARC Clean Technologies, BWXT, GE-Hitachi, General Atomics, Holtec, Moltex, Kairos Power, NuScale Power, Oklo, Radiant, TerraPower, Terrestrial Energy, U.S. Department of Defense, U.S. Department of Energy, U.S. Nuclear Regulatory Commission, Ultra Safe Nuclear Corporation, Westinghouse, X-energy.

FOR MORE INFORMATION

Contact:

Victor Ibarra, Jr.

vibarrajr@nuclearinnovationalliance.org

Introduction

Nuclear Expands
its Family Tree

○ Water Cooled Reactors

○ Non-Water-Cooled
Advanced Reactor
Technology

○ Salt- and Sodium-
Cooled Reactors

○ High Temperature
Gas Cooled Reactors

○ Gas-Cooled
Fast Reactors

○ Micro-Reactors

Advanced Reactor
Demonstration Program
(ARDP)

Glossary

Introduction

What is the problem we're trying to solve?

The world is facing an unprecedented challenge. Stabilizing the climate requires ending the greenhouse gas emissions (GHG) that come from burning oil, coal and gas, which today provide 84% of global energy (78% in the United States). Energy consumption is expected to grow and uncontrolled burning of fossil fuels, in electricity generation, transportation, space heating and industrial uses, will have to be replaced soon, and globally, with carbon-free sources, faster than any previous shift in energy infrastructure.

There will be many substitutes, but a key one will be **advanced fission reactors**. The goal of this primer to provide basic information on advanced reactor technologies. Dozens of designs are under development around the world; **this primer focuses on those in the United States and Canada and their deployment plans in North America**. It is not exhaustive but does include most of the approaches under serious consideration. The field is evolving rapidly, and so will this document; the information here is current as of **July 2023**.

Fossil fuels today are the mainstay not only in electricity generation, but also in transportation, industry, buildings and agriculture, which also contribute a significant amount of GHG emissions. The world must keep fossil fuel emissions out of the atmosphere at a time of rapid growth in energy demand, as billions of people strive to gain the comfort, convenience and prosperity enjoyed by countries with abundant energy, like the United States.

Many technologies will play a part in achieving decarbonization. Advanced nuclear reactors, which offer important advantages that allow a clean, robust, balanced, and diversified energy system. Nuclear energy limits "energy sprawl" because it takes up much less land than other low-carbon energy sources.

Advanced reactors are as different from one another as gouda and gorgonzola, as Beethoven from Bon Jovi. They are related but not the same. What they all have in common is the ability to tap into one of the fundamental forces of nature, the one that binds together the nucleus of the atom. And most will share other characteristics important to the changing energy system:

- + They will be able to operate flexibly, for example, by switching from producing electricity to hydrogen, or load following, so they can complement variable sources like wind and solar and eliminate dependency on carbon-emitting generation to balance supply and demand.
- + Some advanced reactors have the ability to start up independently, something that few power plants today can do, and which will be lost as fossil units are retired. This "blackstart" capability will speed restoration of the energy grid in case of an energy grid blackout.
- + Most will produce heat at higher temperatures than most reactors today, so that they can replace fossil fuels in a wide variety of industries and produce electricity more efficiently.
- + Advanced nuclear reactors are also small enough that they can be part of integrated energy systems, for example, where their waste heat can be used to meet local heating requirements.
- + They are being designed for ease of manufacture and operation, so their costs will be lower and their potential for malfunction will be even more limited than in current-generation reactors.

Introduction

Nuclear Expands its Family Tree

○ Water Cooled Reactors

○ Non-Water-Cooled
Advanced Reactor
Technology

○ Salt- and Sodium-
Cooled Reactors

○ High Temperature
Gas Cooled Reactors

○ Gas-Cooled
Fast Reactors

○ Micro-Reactors

Advanced Reactor
Demonstration Program
(ARDP)

Glossary

Introduction

The value proposition of advanced reactors also includes the following characteristics:

- + They will have safety systems that are simpler and have fewer failure points and thus will improve even further on the strong safety performance of current generation reactors.
- + Their safety and security features will be built in, for example by placing key components below ground, which will make it easier to assure physical security and nonproliferation protections.
- + They may consume materials that are in the used fuel of current-generation reactors that are now considered waste, and they may produce spent fuel in smaller volumes, and in forms that will make disposal easier.

Advanced reactors incorporate decades of progress in nuclear physics, materials science, system engineering, and computer controls. Shifting to new designs is essential in nuclear energy, as it is in other high-technology fields. The transition will require time and capital. Developing a new kind of reactor does not resemble starting up a social media app or a new clothing line.

This new generation of reactors is high tech, but in some ways simpler. Existing reactors assure safety with complex, interlinked

systems that start up when sensors measure a change in reactor power, pressure, temperature or flow rate. Those systems often traditionally involve pumps, pipes, valves, diesel generators and batteries, all of which are built and inspected to very precise standards. But in the new generation, passive and inherent characteristics accomplish the same tasks; for example, cooling water is stored above the reactor and delivered using only gravity, so no pumping is required (passive), or the reactor core is small enough that it cannot build up heat to an extent that will damage the fuel (inherent). Many of the designs are based on such safety features, so operator actions are simply not required in the first hours or days after an incident. Excess heat is dissipated by conduction or by the natural course of hot water rising and cold water sinking, a phenomenon that sets up a flow of water that spreads heat around the reactor and its piping, and thus limits temperature build-up. This process (which engineers call “buoyancy-driven flow”), is in lieu of pumps running on electricity or steam. These characteristics are sometimes referred to by engineers as “passive,” meaning that the system does not rely on active mechanical intervention. (Human operators would continue to monitor the plant systems.) They will improve even further on the already exemplary safety performance of existing nuclear reactors



Advanced reactors incorporate decades of progress in nuclear physics, materials science, system engineering, and computer controls. Shifting to new designs is essential in nuclear energy, as it is in other high-technology fields.

Nuclear Energy Expands its Family Tree

What is "Nuclear Energy"?

There are currently 93 (soon to be 94) operating nuclear reactors in the United States that produce electricity. The fuel is made by mining uranium and processing it into a powder. The powder is then formed into ceramic pellets, which are stacked in rods made of a special metal alloy. The rods are bundled together and submerged in water. Similar to other types of thermal power plants, nuclear power plants use heat to boil water and produce steam. The steam is then used to drive a turbine and make electricity. Nuclear power produces the heat from a process called **fission**, the splitting of uranium atoms. (Researchers are also working to develop **fusion** as an energy source, in which two atoms give off heat as they are squeezed together into one **but this energy technology is not covered in this document.**)

While nuclear reactor technology will change and improve over time, the fundamental concept of splitting atoms to make heat, and using that heat to produce electricity, will remain the same for the upcoming generation of advanced reactors. In addition to electricity, some advanced reactors also may do other work, such as producing heat for industrial uses, district heating, desalination, energy storage, and hydrogen (and ammonia production). To do these jobs, some will build on the traditional ceramic-uranium-water model while other reactor designs employ alternative models. Examples include using uranium in a different fuel form or using a different chemical element altogether, like thorium, which is abundant in nature and when irradiated in a reactor, becomes reactor fuel.

What is "Advanced Nuclear Energy"?

The term "advanced reactor" is defined in the Nuclear Energy Innovation and Modernization Act ([NEIMA](#)), which became law in 2019, as a reactor with significant improvements compared to existing commercial reactors (e.g., "additional inherent safety features; significantly lower levelized cost of electricity; lower waste yields; greater fuel utilization; enhanced reliability; increased proliferation resistance; increased thermal efficiency; or ability to integrate into electric and nonelectric applications"). The definition lists advantages, but does not convey much specific information about new designs. There are also other ways to define advanced reactors and categorize them according to their **neutron spectrum**, (how quickly **neutrons**,

the sub-atomic particles that are emitted when an atom is split and are used to sustain a **chain reaction**, fly around inside the reactors), what kind of atoms they split, the physical form of the fuel they use, the choice of **moderator** (the material that regulates, or slows, the speed of the neutrons to increase the probability of inducing fission), and the **coolant** (which carries away the heat energy so it can do useful work).

All these machines are still nuclear reactors – that is, they make energy by splitting atoms. But like vehicles on the road, they differ from one another, and no one size fits all; that's why we have buses, cars, trucks and motorcycles.

In general, these advanced designs will be important for carbon-free systems in 2030 and beyond, in the U.S. and internationally. They will have the ability to serve:

- Areas with almost no grid support that need reliable, firm capacity in small increments, consistent with their more modest demand (such as rural Alaska, Puerto Rico, remote desert locations, and communities "at the end of the transmission line").
- Independent system operators (ISOs) in need of small, distributed generation to avoid congestion and overloading on the aging transmission system.
- Areas where conventional baseload generation (coal and nuclear) is retiring, and that need 24/7 reliable firm capacity that can be built quickly and located almost anywhere.

Carbon-free systems need carbon-free generation that is reliable, secure, and flexible. They need power plants in a range of sizes and need a mix of centralized and distributed resources. Modular construction will shorten construction time and aid in making this power generation complementary to wind and solar, with their variable output. In the sections that follow, this Primer summarizes the most promising advanced nuclear reactor designs under development in the United States and Canada to meet these needs.

Nuclear Expands its Family Tree

○ Water Cooled Reactors

○ Non-Water-Cooled Advanced Reactor Technology

○ Salt- and Sodium-Cooled Reactors

○ High Temperature Gas Cooled Reactors

○ Gas-Cooled Fast Reactors

○ Micro-Reactors

Advanced Reactor Demonstration Program (ARDP)

Glossary

Nuclear Energy Expands its Family Tree

WHAT ARE THE DIFFERENT TYPES OF NUCLEAR REACTORS?

Categorizing Nuclear Reactors

There are many ways to characterize a nuclear reactor. There is no one way to categorize future reactor designs, but rather many convenient ways to distinguish between them.

Conventional Reactors: Conventional (or existing) reactors, are Pressurized Water Reactors (PWRs), Boiling Water Reactors (BWRs), and the Canada Deuterium Uranium reactor (CANDUs). More information on these designs are provided in the next page (page 7).

Advanced Reactors: The figure to the right provides a visual introduction to some of the different types of advanced reactors technologies that will be covered in this Primer (beginning on Page 9). These include Advanced Light Water Reactors (LWRs), High Temperature Gas Reactors (HTGRs), Molten Salt Reactors (MSRs), Gas-Cooled Fast Reactors (GFR), Sodium Fast Reactors (SFRs), and Lead Fast Reactors (LFRs). Each reactor technology type can be described by its general attributes and functionality, with each design having unique characteristics.

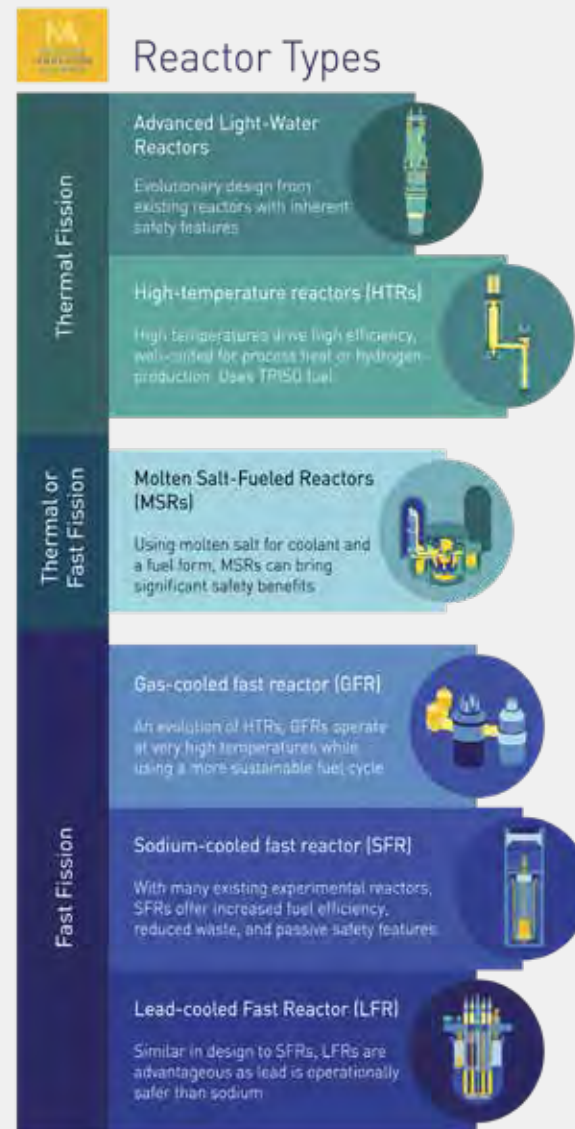

Water-Cooled Reactors

CONVENTIONAL WATER COOLED REACTORS

Understanding the advanced water-cooled reactors requires a quick review of the existing ("conventional") ones.

The first reactors to produce useful energy were developed for the U.S. Navy in a program led by Admiral Hyman Rickover in the late 1940s. Rickover faced a choice of moderator and coolant materials but chose water, partly because it was a substance that Navy engineers were familiar with. The Navy also explored using **liquid sodium** as a coolant for reactors. However, the water-cooled technology could be made practical for submarines faster, and producing a workable product in a short time was a Cold War priority for the U.S. government. Thus, water-cooled reactors became the norm in the Navy and later, the commercial sector.

Today there are two types of water reactors used commercially in the U.S. and a third in Canada to produce electricity. All three use water for two purposes:

1. as a moderator to slow down, or "moderate," the speed of the neutrons emitted during fission to a velocity more likely to split another atom of uranium; and
2. to act as a coolant and carry away the heat created by fission. This heat is transported by the **coolant** and then used to heat another fluid. In other words, water is used as a **heat transfer medium**.

Several terms appropriately describe today's reactors. One is "**light-water reactors**," in which the water used is ordinary water, although highly purified. Light water works well as a heat transfer mechanism, and as a moderator. But the water has a tendency to steal the neutrons needed to sustain the chain reaction and absorb them into its two hydrogen atoms (the H in the familiar

formula H₂O). In nature, uranium comes in two types, called isotopes. **Isotopes** are variations of an element; all isotopes of an element are chemically identical, but they have differing numbers of neutrons, which are sub-atomic particles found in the nucleus. Isotopes have different properties in a reactor. For nuclear reactors, there are only a few isotopes of interest: the isotope uranium-235 (U-235) which splits easily and the most abundant isotope is uranium-238, which does not split easily. To sustain the chain reaction, light-water reactors need a fuel with a higher blend of uranium-235 than occurs in nature. Using this **enriched uranium** also allows the fuel elements to continue producing heat in the reactor for longer.

Unenriched uranium, called **natural uranium**, consists of 0.7 percent uranium-235, with the remainder being almost entirely uranium-238, which does not undergo fission easily. Light-water reactors in the United States are typically fueled with a mix that is between 3 and 5 percent uranium-235. Any enrichment below 20 percent is called "low-enriched uranium," and some advanced designs will require [mixtures toward the higher end of that range](#).

Within light-water reactor technology in the United States, there are two sub-categories: [boiling water reactors \(BWRs\)](#) and [pressurized water reactors \(PWRs\)](#). BWRs boil water into steam in the reactor core and use the steam to drive a turbine to produce electricity. The steam is then condensed back into water using a condenser and recycled back into the reactor. PWRs prevent water from boiling in the reactor by using a pressurizer system. Thus a secondary loop is needed where the primary water in the core heats the secondary loop of water which turns into steam. Like a BWR, the steam is used to drive a turbine to produce electricity. The steam is then condensed back into water

Water Cooled Reactors

Non-Water-Cooled
Advanced Reactor
Technology

- Salt- and Sodium-Cooled Reactors
- High Temperature Gas Cooled Reactors
- Gas-Cooled Fast Reactors
- Micro-Reactors

Advanced Reactor
Demonstration Program
(ARDP)

Glossary

Water-Cooled Reactors

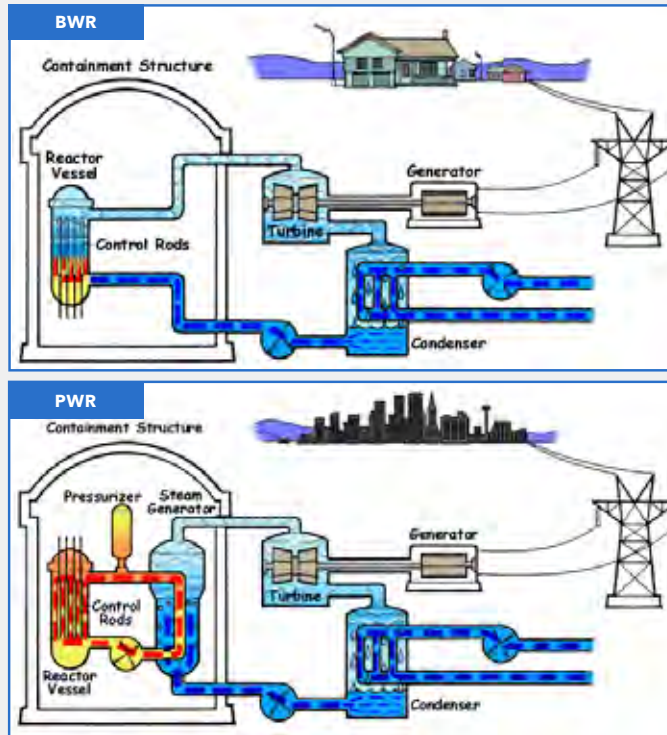

and recycled through the loop to be reheated.

A third type of reactor, used primarily in Canada, is a “**heavy water reactor.**” These reactors use a form of water that is naturally occurring but rare, called deuterium, or heavy water, giving the technology its name CANDU, for Canadian Deuterium Uranium. (The name is also a play on the slang phrase, “can do.”) Heavy water (D₂O) is similar to light (regular) water but the hydrogen atoms have an extra neutron attached to them and thus are less prone to scavenge another from the neutron flow in the reactor core. Canada’s heavy water reactors have several advantages, one of which is that they can run on natural uranium. CANDU reactors also have the added benefit that the reactor core can be refueled without shutting the reactor down. This is known as **online refueling**. It avoids the need to shut down for several weeks every 18 months or 2 years. Canada operates a fleet of heavy water reactors and has committed to extending their operating lives and is also expected to demonstrate

advanced nuclear energy projects by the end of the decade (see GE-Hitachi and USNC).

Light-water reactors are a type of **thermal reactor**, so named because the neutrons have been slowed down into what physicists call the thermal range. This distinguishes them from **fast reactors**, where neutrons are not slowed down and thus have higher energy. Even so, thermal reactors are not slow in human terms; the neutrons are still moving at about 5,000 miles per hour.

Light-water reactors produce steam at temperatures adequate for generating electricity, but current-generation light-water reactors do not run as hot as some fossil plants, and they cannot meet the process heat requirements for some industries that currently use natural gas or other fossil fuels and that must be decarbonized to meet our climate goals.

In terms of safety, light-water reactors are extremely safe but have a small but still present risk of overheating to an extent that will produce fuel damage. The probability of such an incident having off-site consequences is even smaller. Reactors require extensive active back-up systems, which are triggered by changes in temperature, coolant flow or pressure to assure safety. Some newer light-water designs, like the AP1000, also have inherent safety characteristics that do not require active intervention, making the possibility of fuel damage even more remote.

Another example of simpler, passive safe design is when the emergency cooling water is not on the roof, but actually adjacent to the reactor, but separated from it by an insulating vacuum layer. To make use of the cooling water, all the plant needs to do is to fill the vacuum layer with water, and the heat will flow out naturally. That layout has far fewer active parts. And if excess heat can be removed by natural circulation, without pumps, and if the reactor is designed with no large pipes outside the reactor vessel so that there is no pipe break that could result in the loss of large volumes of water, then the design is relying on inherent safety features instead of active systems.

Water-Cooled Reactors

ADVANCED WATER-COOLED REACTOR TECHNOLOGY

There are four major projects in North America, some with backing from the U.S. Department of Energy (DOE), to design and build advanced reactors that will use water as the moderator and the heat transfer medium. All four designs are considered Small Modular Reactors (SMRs), **although this term describes a variety of characteristics including reactor size and the ability to combine multiple standardized modules. The term SMRs does not describe the technology (e.g., PWRs, BWRs, etc).** The four major projects in North America are the Westinghouse AP300 Small Modular Reactor, the NuScale Power Small Modular Reactor, GE-Hitachi's BWRX-300, and Holtec's SMR-160.

Water-cooled, water-moderated advanced reactors have advantages, and extensive experience with water and the chemistry and materials properties that go with its use. And clear water makes visual inspections simple. They also take advantage of existing nuclear fuel supply chains.

While SMRs are typically thought of as water-cooled, the definition also includes other types of technology discussed later in this document. Virtually all advanced (water and non-water based) reactors are also SMRs. Some agencies and developers also define a separate category, "micro-reactors," with electric or heat output an order of magnitude smaller than SMRs (see figure below). Others group these micro-reactor designs with SMRs.



Sizing New Nuclear: The figure below provides a visual introduction to some of the different sizes of advanced reactors technologies that will be covered in this Primer. Traditional reactors are typically 1000 MW in size, and can power 1 million homes but new reactors will come in at a variety of sizes ranging from 1 to 300 MWs in size (or larger) .

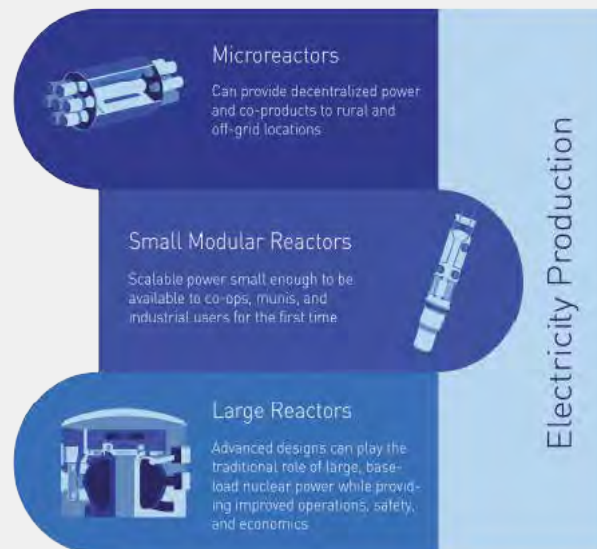

Water-Cooled Reactors

EXAMPLES OF ADVANCED LIGHT-WATER REACTORS UNDER DEVELOPMENT

Westinghouse



AP300 Small Modular Reactor: In May 2023, Westinghouse announced their design for a one-loop, 300 MWe PWR-SMR design. The technology is based on the AP1000, a proven pressurized water reactor design that is already operational in the United States and China. This means that the AP300 will have mature equipment and components, proven inherent safety systems, and a proven fuel and supply chain. The reactor will use Westinghouse's Advanced Doped Pellet Technology (ADOPT), a type of accident-tolerant fuel, and will operate on

a four-year refueling cycle. The size of the reactor is also small, with the reactor expected to fit within an international soccer field. The AP300 SMR will be able to load-follow 15 MWe per minute, produce hydrogen through electrolysis and heat, power desalination plants, and be used in district heating applications. Westinghouse submitted their Regulatory Engagement Plan to the Nuclear Regulatory Commission (NRC) in May 2023. Additional details are forthcoming.

Water-Cooled Reactors

NuScale Power Corp.



NuScale Power Module: A small, modular, factory-built PWR. The reactor core resembles existing PWR technology, but with fuel that is half the height. The reactor sits in a vessel surrounded by a vacuum layer, and an outer steel wall. That outer container sits in a giant pool of room-temperature water. In case of a loss of coolant accident, the design's safety system diverts steam into the space normally kept under vacuum, and the steam condenses into water; the water naturally conducts heat from the core to the outer shell, where it flows into the surrounding pool of water, without mechanical intervention. This SMR is designed to operate flexibly on an electric grid with lots of intermittent wind and solar generation. It can be configured with a dry condenser, eliminating almost all of its need for cooling water, and increasing flexibility in siting. Safety is inherent in the design; there is no need for operator action, emergency power, or emergency water in the case of a system failure. NuScale's strong safety case justifies an emergency planning zone (EPZ) in the U.S. that only extends as far as the site boundary (as opposed to 10 miles for current U.S. plants), allowing the NuScale plant to be sited in close proximity to process heat off-takers, for district heating near population centers, and to repower retiring coal stations using existing transmission lines. In October 2022, the

Advisory Committee on Reactor Safeguards (ACRS) validated NuScale's Planning Zone boundary methodology marking a significant success for the company's safety design features.

In September 2020, the NRC approved NuScale's 50 MWe initial design, which means that customers can move forward with plans to develop NuScale power plants. A plant can contain up to twelve modules, but some customers may opt for a smaller number of modules. The rulemaking went into effect in February 2023. Additionally, NuScale has amended their original design to have their modules produce 77 MWe and is seeking regulatory approval of the modification. An application for the 77MWe design was submitted in December 2022. NuScale is also currently in Phase 2 in Canada's Nuclear Safety Commission's Vendor Design Review (VDR) process.

Under a 2015 agreement between UAMPS and NuScale, a NuScale VOYGR plant will be built at Idaho National Laboratory (INL), with the first module coming online in 2029. In May 2022, NuScale Power completed a previously announced merger with Spring Valley Acquisition Corp., marking the first advanced reactor company to go public.

Water-Cooled Reactors

GE-Hitachi



GE-Hitachi BWRX-300: A 300 MWe BWR-SMR with passive safety systems. Whereas current BWRs have pumps and associated piping outside the reactor vessel, the BWRX-300 employs natural circulation and has an integrated reactor vessel isolation system, eliminating the possibility of leaking significant amounts of coolant outside the reactor coolant pressure boundary. It is protected from overheating by natural forces like convection and gravity that do not require human action or triggering of mechanical systems. The key BWRX-300 innovation is the elimination of large Loss-of-Coolant Accidents (LOCAs). This innovation enables simpler passive safety systems and a more compact reactor building compared to prior Light Water Reactor (LWR) designs.

In December 2021, [Ontario Power Generation \(OPG\)](#) selected

[the BWRX-300](#) to be deployed at the Darlington site in Ontario, the only site in Canada currently licensed for new nuclear energy and in January 2023, both companies signed a contract to build the reactor by 2028/2029. The License to Construct application was submitted by OPG in 2022, and GEH completed Phase 1 and Phase 2 of the [VDR process in Canada](#). In February and June 2022 respectively, [TVA](#) and [SaskPower](#) also selected the BWRX-300 for deployment in Tennessee and Saskatchewan. Additionally, TVA, Synthos Green Energy and OPG [announced in March 2023 a technical collaboration agreement](#) in which each of these three companies will fund a portion of GEH's overall cost, with a long-term goal of a final BWRX-300 design that will be licensed and deployed in Canada, the United States, and Poland.

Water-Cooled Reactors



Holtec SMR-160: A simplified PWR design with an output of 160 megawatts, it includes a cooling system with no need for pumps or valves. It incorporates safety features that include a reactor core that, in case of malfunction, would be cooled by natural circulation and the tendency of heat to dissipate, referred to as a passive core cooling system. With no need for outside electricity to maintain safety, it can operate independently, on a micro-grid, and can start up without outside assistance. It is designed to run on fuel that is already commercially available, and can operate flexibly, making it a carbon-free complementary source to variable wind and solar. Holtec already fabricates equipment for the nuclear industry, including dry storage casks, and is equipped to manufacture key components of the SMR-160 in-house. In pre-licensing activities, Holtec has begun submitting technical reports to the NRC that will be required for licensing. Holtec is in Phase 1 of the Canadian vendor design review process. In case of equipment malfunction, no operator action

is required to maintain safety. Holtec is decommissioning the old Oyster Creek nuclear plant in Forked River, NJ, and is considering the site for a demonstration SMR-160.

In June 2022, Holtec announced the submission of their [final loan application to the DOE's Loan Program Office](#). The \$7.4 billion loan request would help Holtec demonstrate their SMR-160 technology and bolster Holtec's manufacturing facilities at their Camden, NJ and Pittsburgh, PA sites. Under the loan request, Holtec would build a four-pack SMR-160 power plant at a site to be determined. The LPO application submission was accompanied by the announcement of a [Memorandum of Understanding \(MOU\) between Holtec and Entergy](#). The MOU states that Entergy will evaluate the feasibility of deploying one or more SMR-160s at one of its existing nuclear power plant facilities (Arkansas Nuclear One, Grand Gulf, River Bend, Waterford, or St. Francisville).

SMALL MODULAR LIGHT WATER REACTORS (LWRs)

	BWRX-300 GE-Hitachi	AP300™ Westinghouse	NuScale Power Module™ NuScale Power Corp.	SMR-160™ Holtec
FUNCTION	Flexible Electricity, Hydrogen Production, Desalination, Black start capability, District Heating	Flexible Electricity, Hydrogen Production, Desalination, Black start capability	Flexible Electricity, Hydrogen Production, Desalination, Black start capability	Flexible Electricity, Hydrogen Production, Desalination, Black start capability
NEUTRON SPECTRUM	Thermal	Thermal	Thermal	Thermal
MODERATOR	H ₂ O	H ₂ O	H ₂ O	H ₂ O
HEAT TRANSFER MECHANISM	H ₂ O	H ₂ O	H ₂ O	H ₂ O
OUTLET TEMP	287 °C	~300°C	314 °C	316 °C
FUEL				
Enrichment	LEU	LEU	LEU	LEU
Fuel Form	Ceramic UO ₂ Pellets	Ceramic UO ₂ Pellets	Ceramic UO ₂ Pellets	Ceramic UO ₂ Pellets
Refueling Period/Method	12-24 months	12-24 months	18 months	42 months
POWER OUTPUT				
Classification	LWR-SMR	LWR-SMR	LWR-SMR	LWR-SMR
Base Model Output (MWe)	300 MWe	300 MWe	77 MWe	160 MWe
Plant Scalability Output (MWe)	TBD	Unknown	924 MWe (77 MWe x12) 462 MWe (77 MWe x 6) 308 MWe (77 MWe x 4)	TBD
REGULATORY PROGRESS				
Government Support			\$656 million to date in cost-shared financial assistance awards	
NRC Status	Preapplication Engagement; Construction Permit Application Expected FY 23	Regulatory engagement plan submitted May 2023; Design certification anticipated by 2027	77 MWe Standard Design Approval for NuScale Module submitted in January 2023;	Preapplication Engagement
CNSC Status	License to Construct submitted October 2022; VDR Phase 1 and 2 completed March 2023	Unknown	VDR Phase 2 in progress	VDR Phase 1 complete, Phase 2 expected
Deployment Expected	Darlington (Canada) Site: 2028 Clinch River (USA) Site: 2032	Not publicly available	CFPP (USA) Project: 2029	Not publicly available

Non-Water-Cooled Advanced Reactor Technology

FUEL FOR ADVANCED REACTORS

Most power reactors run on Low-Enriched Uranium (LEU). The current generation of U.S. power reactors uses fuel enriched to typically between 3 and 5 percent, meaning that the concentration of U-235, the type that is **fissile**, or easy to split, is 3 to 5 percent; the rest is U-238, which does not usually fission in U.S. commercial reactors. (However, U-238 is **fertile**, meaning that it can absorb a neutron and become plutonium-239, which is fissile and can be consumed in the reactor.)

Many advanced reactor designs will require the use of a different kind of LEU, High-Assay Low-Enriched Uranium (**HALEU**) fuel. The key difference between HALEU and LEU fuel used in commercial reactors today is the concentration of U-235; in HALEU it is greater than 10% but less than 20%. The use of HALEU instead of LEU is important because it enables the use of new fuel types and operational modes for advanced reactors. The additional fissile material in HALEU allows small reactors to extract more energy per unit of volume and can allow designs to operate for an extended time between refuelings. In certain designs, a single fuel load will last for the lifetime of the reactor. There is currently no commercial supply of HALEU in North America because there has not historically been commercial demand for HALEU fuels. The primary commercial supply of HALEU on the international market is from Russia but the 2022 Russian invasion of Ukraine has introduced significant uncertainty into long-term supply stability.

Source: Department of Energy

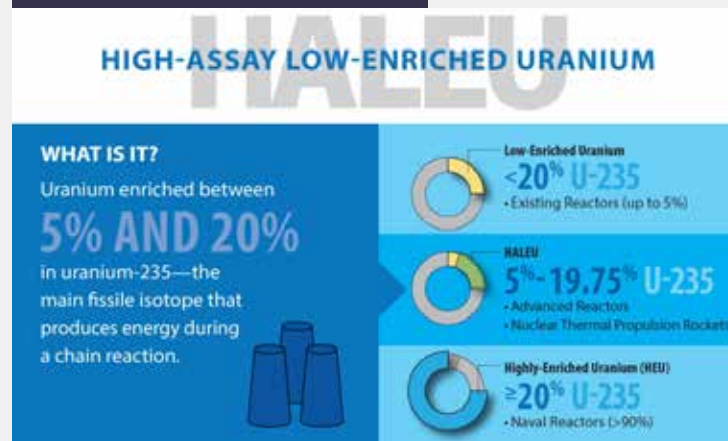

There is no technological obstacle to commercial production of HALEU, but commercial enrichment and nuclear fuel cycle companies in the U.S. and Europe have not made significant investment in new HALEU production infrastructure. The Inflation Reduction Act enacted in 2022 [provided initial funding for HALEU production in the United States \(\\$700M\)](#), but more is needed. Companies report that strong demonstrated demand for HALEU is required to justify the capital investment in new enrichment infrastructure. At the same time, the advanced reactors designed to use HALEU cannot be deployed at scale without strong assurances of long-term HALEU availability. Advanced reactors under development today that require HALEU will need new supply for long term operation. While HALEU is not yet commercially available domestically, the DOE has begun work to catalyze development of commercial markets and assure HALEU supplies for advanced reactors. DOE has promised to provide the first fuel load of HALEU for Oklo’s micro-reactor, the Aurora Powerhouse. This particular HALEU is being made with “used fuel,” previously used in DOE test and research reactors. This re-use of fuel, however, may be a workable solution for many advanced reactors. The DOE is currently working to identify HALEU sources for advanced reactors that cannot utilize “used fuel”. To address the overall problem of domestic supply, Congress has also ordered DOE to enable more HALEU production. The Department is developing a plan to establish a supply in partnership with commercial nuclear fuel cycle companies. Additional details on the challenges and solutions for catalyzing HALEU market development can be found in the NIA Report, [Catalyzing a Domestic Commercial Market for High-Assay, Low-Enriched Uranium \(HALEU\)](#).

Some reactor vendors will use specific HALEU fuel designs, like TRISO, which stands for TRI-structural ISOtropic particle fuel. TRISO fuel are little kernels of uranium surrounded by concentric layers of carbon and ceramic materials that cannot melt in a nuclear reactor. They are very small (the size of a poppy seed) and are very robust. DOE has invested approximately \$400M - \$500M in developing, characterizing, irradiating and analyzing TRISO fuel over the past 15 years. DOE is also currently supporting TRISO fuel research through [the Advanced Reactor Technologies \(ART\) program](#).

Non-Water-Cooled Advanced Reactor Technology

THE ADVANTAGES OF FAST REACTORS

Some advanced reactors will be “fast reactors.” The benefit of using non-moderated or “fast” neutrons in reactor operation is that they (the neutrons in the reactor) have much more energy and thus have a higher probability of utilizing hard-to-split atoms as nuclear fuel, like uranium-238, which is abundant in nature. Another advantage is fast reactors consume some hard-to-manage isotopes called **actinides** that are produced in today’s operating light-water reactors and make up part of Used Nuclear Fuel. These actinides are created when atoms in the fuel are hit by a neutron, and instead of splitting, absorb it, transmuting them into a new material. These atoms tend to have long lifetimes, and thus make disposal of used fuel more complicated.

When a fast reactor splits these actinides, the resulting fragments are radioactive for a shorter period, which potentially

simplifies spent fuel disposal. The reactor also derives energy value from splitting those atoms. Fast reactors also offer the potential of higher **uranium utilization**, meaning that more of the uranium in the fuel is fissioned, or split, to make energy, and less is left in the fuel when it is removed from the reactor. This is one of the main attraction for fast reactor, as they open up the opportunity for **breeder reactors**, which produce more fuel than they consume. For reference, **more than 90%** of used light-water reactor fuel’s potential energy still remains in the fuel, even after years of operation in a reactor. Advanced reactors can help close this gap.



Fast reactors also offer the potential of higher uranium utilization, meaning that more of the uranium in the fuel is fissioned, or split, to make energy, and less is left in the fuel when it is removed from the reactor.

Non-Water-Cooled Advanced Reactor Technology SALT-COOLED AND SODIUM-COOLED REACTORS

SALT-COOLED AND SODIUM-COOLED REACTORS

Instead of water as the **heat transfer medium**, some reactors will use **molten salt** or liquid metals, like **FLiBe Molten Salt** or Liquid Sodium. These materials do not expand nearly as much as water when heated, so the reactors can run at higher temperatures and lower pressures (at atmospheric or near atmospheric), an advantage in construction cost design and preventing loss of coolant accidents (because they don't require large pressure vessels and piping that can withstand extremely high pressure, unlike light-water reactors). Thermodynamically, higher temperature equals higher electricity generation efficiency, meaning more kilowatt-hours per BTU of heat produced in the reactor. Other safety characteristics include the use of an **intermediate heat exchanger system**, which will prevent the release of radioactive material in the event of sodium-water interaction.

Liquid sodium is a weak neutron moderator, meaning that the neutrons that are used to sustain chain reactions do not slow down much between interactions with other nuclei, a sharp contrast to a water-based reactor. These unmoderated neutrons are referred to as **fast neutrons**. (Sodium reactors can still be moderated, but not by the sodium; designers can insert solid pieces of graphite to slow the neutrons, if desired.) In addition to being a weak moderator, sodium has another important characteristic in a reactor: it has a large "**liquid temperature range**," meaning that it remains a liquid at very high temperatures. That is desirable because as long as it does not boil into a gas, it does not expand much; hence it can transfer heat at very high temperatures but low pressures, simplifying design and construction of the reactor.

Other metals, including molten lead, have been demonstrated, but engineers like sodium because it does not tend to corrode metal components.

FLiBe reactor coolant is chemically stable and has a very high boiling temperature (meaning it will remain a liquid at all operating temperatures). FLiBe also has a tremendous affinity for radioisotopes and serves as a secondary layer of containment in the unlikely event that fission products escape from the fuel.

Most molten salt reactors use one of three classes of salt:

1. Fluorides with low (or no) concentrations of nuclear material
2. Fluorides in which the nuclear material make up a substantial portion
3. Chlorides in which nuclear materials make up a substantial portion

Operation of reactors with their fuel dissolved in molten salt allows for tremendous heat transfer capability (the fuel is in the heat transfer material) and retains fission products. Refueling and fission product removal can be performed online, potentially yielding high availability.

Non-Water-Cooled Advanced Reactor Technology SALT-COOLED AND SODIUM-COOLED REACTORS

EXAMPLES OF SALT- AND SODIUM-COOLED REACTORS UNDER DEVELOPMENT

TerraPower



Natrium: In partnership with GE-Hitachi, TerraPower was one of two awardees selected by the U.S. DOE to demonstrate its Natrium technology under the Advanced Reactor Demonstration Program (ARDP). The design features a sodium-cooled “fast” reactor, which draws on earlier TerraPower’s [TWR](#) and GE’s [Prism](#) designs, to produce heat and electricity. The reactor will use zirconium alloy fuel rods, and uranium fuel, which sits in a pool of liquid sodium. The reactor is coupled with a molten salt energy storage system that serves as a reservoir that will store enough heat to produce hundreds of megawatt-hours of electricity on demand allowing the technology to couple well with renewable energy generation. As a fast reactor, future versions of Natrium may consume some long-lived isotopes that are produced when a reactor runs. Consuming them adds to efficiency and reduces the volume of nuclear waste through higher fuel utilization.

The molten salt storage system, essentially a huge tank, is coupled with a conventional, non-nuclear electricity generating system consisting of a heat exchanger that boils water into steam, and then a conventional turbine and generator. Because the temperature of the salt tank can be allowed to vary over a wide range, the heat exchanger can pull energy out of the tank according to the needs of the electricity grid, and can vary its output from 100 megawatts to 500 megawatts. The reactor runs at a steady output of 345 megawatts. On a grid with extensive

solar resources, the plant would put out 100 megawatts during daylight hours, but could run at 500 megawatts for 5.5 hours around sunset and into the evening when demand is high. Moving the reactor’s heat into a storage tank instead of directly to the turbine-generator also insulates the reactor from brief anomalies on the grid or in the generator, which in a standard design can cause the reactor to shut down. In case of equipment malfunction, no operator action is required to maintain safety.

The total ARDP DOE award is worth up to \$1.97 billion. In [November 2021, TerraPower selected](#) Kemmerer, Wyoming as the demonstration site for the Natrium reactor, marking the only coal-to-nuclear project underway in the world. PacifiCorp will be the operator of the ARDP demonstration plant. TerraPower expects to submit a construction permit application in 2023. In October 2022, GE-Hitachi’s Global Nuclear Fuel and TerraPower announced they will be building a fuel fabrication facility in North Carolina. In December 2022, TerraPower also announced over \$800 million raised from private investors.

Non-Water-Cooled Advanced Reactor Technology SALT-COOLED AND SODIUM-COOLED REACTORS

TerraPower



Molten Chloride Fast Reactor: In partnership with Southern Company, TerraPower will develop their Molten Chloride Fast Reactor (MCFR) technology. MCFR will utilize molten salt as 1) the dissolved fuel and 2) the heat transfer mechanism. The reactor will also operate under a fast neutron spectrum. The fast neutron spectrum is the primary difference between other MSR designs and TerraPower's MCFR. Using molten chloride salts will allow the reactor to operate under fast neutron spectrum conditions.

In December 2020, the Department of Energy announced Southern Company and TerraPower as a Risk Reduction ARDP winner for the MCFR technology. Under the award, they will demonstrate the technology at the Idaho National Laboratory under a project titled the Molten Chloride Reactor Experiment (MCRE). The project will be world's first fast spectrum salt reactor and will provide crucial operating data for future molten salt reactor projects. The experiment is expected to be operational

by 2025 or 2026 and will operate at up to 150 kWth.

As a fast reactor, future versions of MCFR may consume some long-lived isotopes that are produced when a reactor runs. Consuming them adds to efficiency and reduces the volume of nuclear waste through higher fuel utilization. In March 2022, TerraPower received an \$8.5M ONWARDS award from ARPA-E to create a method for the recovery of uranium from used nuclear fuel with integrated safeguards that harness the volatility of chloride salts at high temperatures. In addition to using molten salt for heat transfer, MCFR is also expected to be paired with a molten salt energy storage system, like Natrium's. MCFR will come in two different sizes, either 300 MWe or 780 MWe. The project is expected to reach commercial maturity in the 2030s.

Non-Water-Cooled Advanced Reactor Technology SALT-COOLED AND SODIUM-COOLED REACTORS

Terrestrial Energy



Integral Molten Salt Reactor: The Integral Molten Salt Reactor® (IMSR) will generate 195 megawatts of electricity and use low-enriched uranium fuel dissolved in molten salt. Control of the reaction is achieved in part by the shape of the container that holds the fuel. In operation, the fuel is located in a vessel with a shape that creates a critical mass and the volume and geometry needed to sustain a chain reaction. The molten-salt liquid-fuel mixture is circulated between graphite moderator panels and a heat exchanger, so heat can be drawn off to produce electricity, or can be used for other purposes, to displace fossil fuels. In addition, fuel can be added while the reactor is operating, so it does not need to shut down for refueling.

All the nuclear components are inside the reactor core, and the reactor core is sealed and not opened during operation. Every seven years, the entire core is replaced by another in an adjacent silo. The balance-of-plant lifetime is designed for eight such cycles, or 56 years. The economics of a modular core are favorable compared to the light water fuel assemblies used in

current-generation reactors. Modular replacement is quick, and the core module includes the structural, non-fuel elements of the core, which otherwise would have to be inspected every few years for age-related deterioration. In case of equipment malfunction, no operator action is required to maintain safety.

Terrestrial Energy has completed Phase 1 and Phase 2 of the VDR process with the CNSC. The Canadian federal government has also invested \$20 million in the project. In June 2022, the U.S. Nuclear Regulatory Commission and the Canadian Nuclear Safety Commission completed a first joint technical review of the IMSR as part of a regulatory program established in August 2019 by the NRC and CNSC. The joint technical review signals the potential for advanced nuclear energy licensing harmonization across borders. In November 2022, TerraPraxis, an NGO focusing on coal repowering, selected Terrestrial Energy for their Repowering Coal Consortium. Terrestrial Energy also won a DOE award in May 2023 to submit a standard design approval to the Nuclear Regulatory Commission.

Non-Water-Cooled Advanced Reactor Technology SALT-COOLED AND SODIUM-COOLED REACTORS

Moltex



SSR: The 300 megawatt Stable Salt Reactor can also run on components of spent fuel from other reactors, after the fuel components have been chemically separated, as well as reactor-grade plutonium. Thus it reduces the quantity and toxicity of spent fuel. The reactor runs at a negative pressure, so if there is a leak, ambient air flows in rather than coolant flowing out. Refueling is performed while the reactor is on line. In the Moltex design, as with other reactors, the core continues producing heat after the reaction is shut down through radioactive decay. But this decay heat is **removed by air flow**, without pumps, valves or extra coolant. No emergency core cooling system is required.

The design received a \$50.5 million award from the Government of Canada to bring the reactor closer to commercialization. The company is planning with New Brunswick Power to build the first reactor. It is also working with Ontario Power Generation on a **plan to recycle used fuel from CANDU reactors**. Moltex has applied for Phase 1 and Phase 2 of the VDR process and is currently undergoing Phase 1 assessment by the CNSC. Moltex has received \$7 million from the DOE's Advanced Research Projects Agency-Energy, and \$45 million (in U.S. dollars) from the Canadian government. In June 2023, they also received a US DOE **voucher** for testing.

Non-Water-Cooled Advanced Reactor Technology SALT-COOLED AND SODIUM-COOLED REACTORS

Kairos Power

New Iteration in Hermes Demonstration Reactor Series

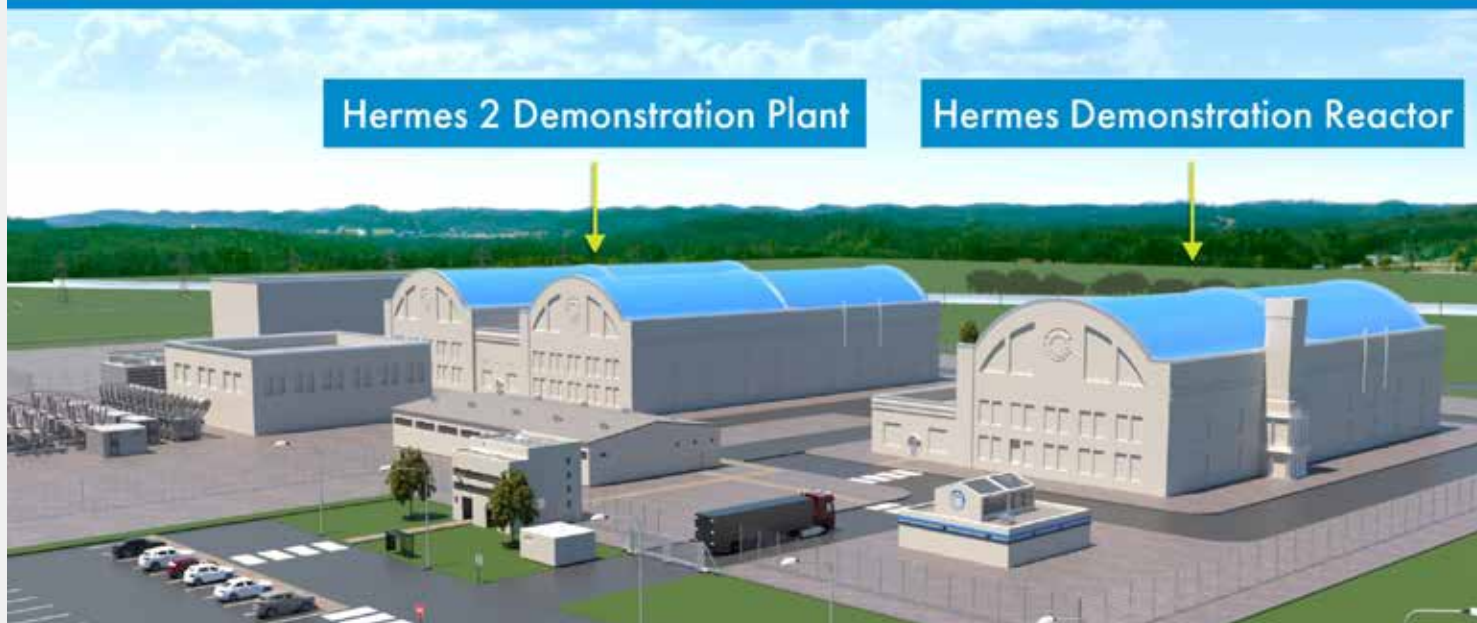

Hermes and KP-FHR: In September 2021, Kairos submitted to the NRC a construction permit application to build the Hermes Low-Power Demonstration Reactor at the East Tennessee Technology Park (ETTP) in Oak Ridge, Tennessee. This reactor will be followed by Hermes 2 and a fleet of commercial power reactors. The Kairos Power Fluoride Salt-Cooled High-Temperature Reactor (KP-FHR) design is a “pebble-bed” reactor, meaning that it will run on fuel consisting of TRISO particles aggregated into golf-ball-sized pebbles in a configuration reminiscent of a gumball machine. Unlike other designs that use TRISO pebbles, KP-FHR pebbles float in molten fluoride salt that carries heat away from the fuel. The reactor will operate as a high-temperature, low-pressure system. High temperature allows the reactor to make electricity more efficiently and to

do other kinds of work. Low pressure contributes to a more robust safety case. Pebbles will be removed and added during operation for on-line refueling. Other graphite components also provide moderation of the neutrons. The pebbles themselves are a good container for nuclear waste once the fuel is removed from the reactor. A commercial Kairos reactor will deliver 140MW_e, but the Hermes reactor will produce only heat, not electricity, since it is a demo reactor. The power level of the Hermes reactor will be 35 MW_{th}. Hermes 2 is expected to produce electricity. Under the Advanced Reactor Demonstration Program, Kairos Power was **awarded \$303 million** for the \$629 million project to build Hermes. The NRC issued its final safety evaluation for the Hermes construction permit in June 2023 and is expected to issue the permit in Q4 2023.

Non-Water-Cooled Advanced Reactor Technology SALT-COOLED AND SODIUM-COOLED REACTORS

ARC Clean Technology



ARC-100: The **ARC-100** Advanced Small Modular Reactor is a sodium cooled fast reactor using high assay low-enriched uranium (HALEU) metallic fuel with a twenty-year refueling cycle. The ARC-100's simple, modular design provides 100 megawatts of cost competitive electricity and high-quality heat well suited for industrial uses. The ARC-100 has been selected by New Brunswick Power in Canada for deployment at their Point Lepreau site with completion targeted for the late 2020s. ARC Clean Technology has completed Phase I of the Vendor Design Review with the CNSC in Canada and is currently in the midst of

Phase 2. In 2023, New Brunswick Power submitted a License to Prepare Site application to the CNSC. ARC Clean Technology has been awarded USD27.5 million by DOE as part of the Advanced Reactor Demonstration Program and CAD25 million from the Province of New Brunswick, Canada. In December 2022, **the Port of Belledune and Cross River Infrastructure** chose to pursue the ARC-100 for their planned Green Energy Hub, which proposes to use SMR technology to generate a minimum of 1GW of zero-emission firm heat and power for industrial users and hydrogen production at the port.

Non-Water-Cooled Advanced Reactor Technology SALT-COOLED AND SODIUM-COOLED REACTORS

Abilene Christian University



Molten Salt Research Reactor: The Nuclear Energy eXperimental Testing Research Alliance (NEXTRA), led by Abilene Christian University, is a research alliance between four universities. The other universities are Texas A&M University, the Georgia Institute of Technology, and the University of Texas at Austin. Launched in Spring 2019, the consortium's goal is to design, license and commission the first university-based liquid fueled molten salt research reactor, which ACU will host and own. In August 2022,

Abilene Christian University submitted a construction permit application for a molten salt research reactor. As a research reactor, the facility will not produce power and will be able to operate up to 1MWth. The reactor will use High Assay Low Enriched Uranium (HALEU) dissolved in Flibe salt. Per the NRC website, the NRC will make a final safety determination on the construction permit by Q2 2024. After receiving a determination, an Operating License is required before operation of the reactor

ADVANCED NUCLEAR REACTOR TECHNOLOGY

A PRIMER

Introduction

Nuclear Expands its Family Tree

○ Water Cooled Reactors

● Non-Water-Cooled Advanced Reactor Technology

○ Salt- and Sodium-Cooled Reactors

○ High Temperature Gas Cooled Reactors

○ Gas-Cooled Fast Reactors

○ Micro-Reactors

Advanced Reactor Demonstration Program (ARDP)

Glossary



MOLTEN SALT REACTORS (MSRs)

	Molten Chloride Fast Reactor TerraPower	Molten Salt Research Reactor™ Abilene Christian University	Integral Molten Salt Reactor™ Terrestrial Energy	Stable Salt Reactor™ Moltex
FUNCTION	Flexible Electricity, Molten Salt Energy Storage, Process Heat	University-led Research Program	Flexible Electricity, Desalination, Chemical Synthesis, Black start capability	Flexible Electricity, Desalination, Hydrogen, UNF Recycling, Black start capability
NEUTRON SPECTRUM	Fast	Thermal	Thermal	Fast
MODERATOR	None (Fast)	Graphite	Graphite	None (Fast)
HEAT TRANSFER MECHANISM	Molten Chloride Salt	Molten Fluoride Salt	Molten Fluoride Salt	Molten Fluoride Salt
OUTLET TEMP	735 °C	500 °C	>600 °C	700 °C
FUEL				
Enrichment	HALEU	HALEU	LEU	HALEU
Fuel Form	U-Molten Chloride	U-Molten Fluoride	U-Molten Fluoride	Solid Fuel
Refueling Period/Method	Online	Online	Online	Online
POWER OUTPUT				
Classification	MSR-SMR (mid-scale)	MSR-Micro	MSR-SMR	MSR-SMR
Base Model Output (MWe or MWt)	300-170-430* MWe (mid-scale) 780-650-910* MWe (large-scale)	Test Reactor: 1 MWth	195 MWe	300-500 MWe
Plant Scalability Output (MWe)			390 MWe (x2)	
REGULATORY PROGRESS				
Government Support	One of five ARDP Risk Reduction awards with DOE support of \$136M on total project of \$171M	\$30.5M USD	\$40M CAD investment by Canadian federal government, and support from Ontario Power Generation	\$40M CAD million investment by Canadian federal government, and support from Ontario Power Generation
NRC Status	Preapplication Engagement	Construction permit submitted in 2022.	Standard design approval application Expected FY23	
CNSC Status	None	None	VDR Phase 1 and Phase 2 complete	VDR Phase 1 complete, Phase 2 expected
Deployment Expected	INL (USA) Test Experiment Project: 2025/2026	ACU (USA) Site: Late 2020s	Not publicly available	Not publicly available

*Reactor produces a constant power level. With heat storage in salt, generator output can be varied, depending on grid requirements.

MOLTEN FLUORIDE SALT-COOLED HIGH-TEMPERATURE REACTOR (FHR)

	KP-FHR™ Kairos Power
FUNCTION	Flexible Electricity
NEUTRON SPECTRUM	Thermal
MODERATOR	Graphite
HEAT TRANSFER MECHANISM	Molten Fluoride Salt
OUTLET TEMP	650 °C
FUEL	
Enrichment	HALEU
Fuel Form	TRISO
Refueling Period/Method	Online
POWER OUTPUT	
Classification	FHR-SMR
Base Model Output (MWe or MWt)	140 MWe
REGULATORY PROGRESS	
Government Support	DOE ARDP Risk Reduction Award Winner - \$629 million cost-shared agreement; DOE share: \$303 million
NRC Status	Construction permit application submitted Q4 2021; expected Q4 2024
CNSC Status	None
Deployment Expected	Hermes (USA) Test Reactor Project: 2026 Hermes 2 (USA): Late 2020s

SODIUM COOLED FAST REACTORS (SFRs)

	Natrium™ TerraPower/GE Hitachi	ARC-100™ ARC Clean Technology
FUNCTION	Flexible Electricity, Desalination, Chemical Synthesis, Black start capability	Flexible Electricity, Desalination, Chemical Synthesis, Black start capability
NEUTRON SPECTRUM	Fast	Fast
MODERATOR	None (Fast)	None (Fast)
HEAT TRANSFER MECHANISM	Liquid Sodium	Liquid Sodium
OUTLET TEMP	540 °C	510 °C
FUEL		
Enrichment	HALEU	HALEU
Fuel Form	Metallic U-Zr	Metallic U-Zr
Refueling Period/Method	24 months	up to 240 months
POWER OUTPUT		
Classification	SFR-SMR	SFR-SMR
Base Model Output (MWe or MWt)	345-100-500 MWe*	100 MWe
REGULATORY PROGRESS		
Government Support	DOE ARDP Demonstration Award Winner (\$1.97 billion)	US\$27.5 million awarded by DOE ARDP ARC-20 Program; CAD25 million awarded by Province of New Brunswick, Canada
NRC Status	Pre-application engagement; Construction permit application expected FY23	Preapplication engagement
CNSC Status	None	License to Prepare Site submitted in 2023
Deployment Expected	ARDP (USA) Project Demonstration: 2030	Point Lepreau (Canada) Project: 2029

*Reactor produces a constant 345 MWe. With heat storage in salt, generator output can be varied from 100 MWe to 500 MWe, depending on grid requirements.

Non-Water-Cooled Advanced Reactor Technology HIGH TEMPERATURE GAS COOLED REACTORS

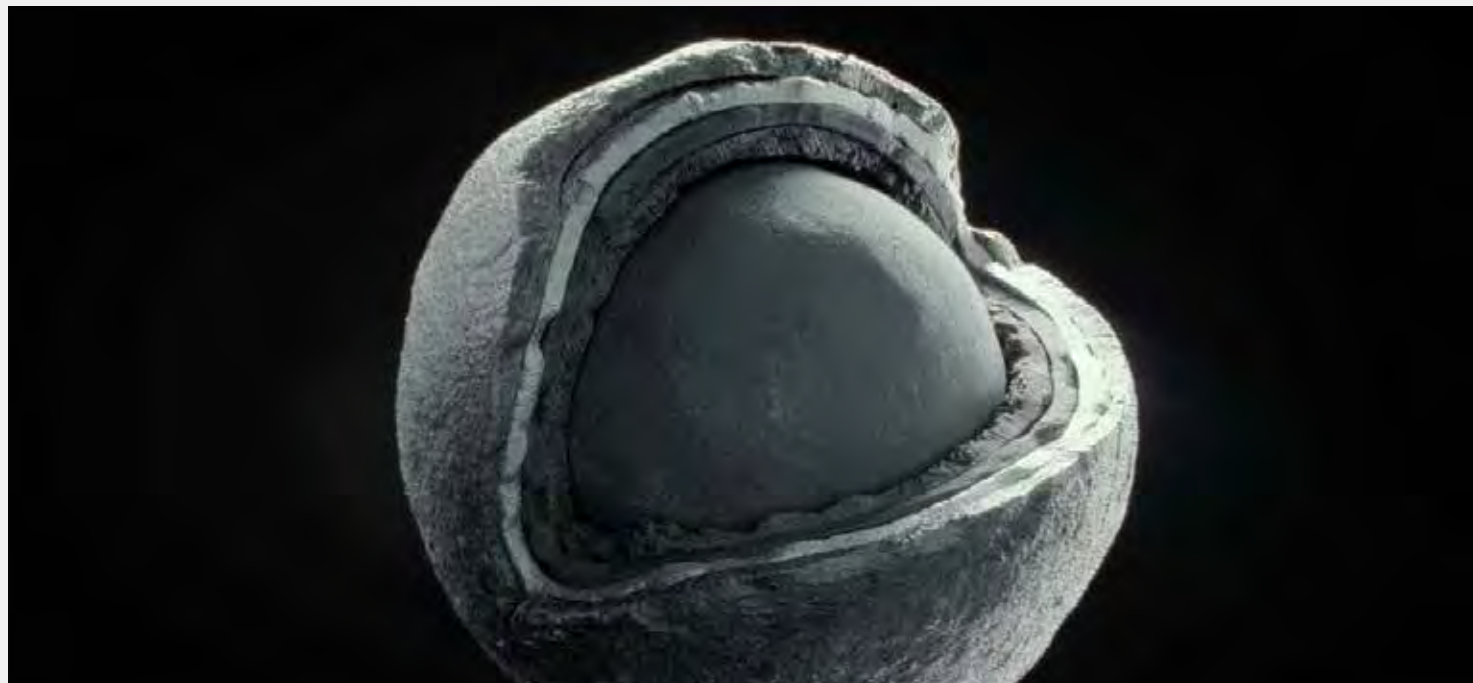

TRISO: A fuel “pebble” of the type most commonly planned for high temperature gas reactors but can also be used in other reactor designs (see some micro-reactor designs and FHR designs). These pebbles, which range in size from ping pong balls to tennis balls, contain particles of uranium or other fissile fuels, coated in silicon carbide or other heat-tolerant materials (see figure above). Photo Source: USNC

This reactor type produces high temperatures while system pressure varies by reactor design. Gas-cooled reactors operating in the thermal spectrum use graphite as a moderator; fast-spectrum reactors do not use a moderator. This is because graphite absorbs very few neutrons, and is stable at high temperatures but requires low neutron exposure to avoid damaging the graphite. This reactor type produces high temperatures while operating at varying pressure levels. No water is used in these reactors for cooling. Instead, an inert gas, typically helium, is used as the coolant and heat-transfer medium

but other gases, like carbon-dioxide, have also been explored. Helium is favored because it is an inert gas and thus does not react with other materials or cause deterioration in components. In most designs, the gas is compressed and run through multiple heat exchangers, to produce steam and subsequently, electricity. HTGRs produce high temperature steam (heat) as well as electricity, so the reactor output could be utilized for many applications like desalination, producing hydrogen, or other industrial processes.

Introduction

Nuclear Expands
its Family Tree

○ Water Cooled Reactors

● Non-Water-Cooled
Advanced Reactor
Technology

○ Salt- and Sodium-
Cooled Reactors

○ High Temperature
Gas Cooled Reactors

○ Gas-Cooled
Fast Reactors

○ Micro-Reactors

Advanced Reactor
Demonstration Program
(ARDP)

Glossary

Non-Water-Cooled Advanced Reactor Technology HIGH TEMPERATURE GAS COOLED REACTORS

EXAMPLE OF GAS REACTORS UNDER DEVELOPMENT

X-energy



Xe-100: The Xe-100 is an 80 megawatt pebble-bed reactor that uses inert helium as the coolant and energy transfer mechanism. It is a high-temperature gas reactor running at lower pressures than water-based reactors. The high temperature steam produced can be utilized for electricity, industrial processes, hydrogen production, and other applications. The modular design can be scaled up to a 320 megawatt power plant in a 4-reactor configuration. The reactor is continuously fueled (TRISO pebbles can be changed out for new ones), and thus, the reactor can be refueled while operating. The TRISO fuel form is also a good package for containing nuclear waste because it will hold the fission products, which are radioactive, in place for the long term. In case of equipment malfunction, no operator action is required to maintain safety.

In December 2022, X-energy announced they would be going public, marking the second advanced nuclear company to do so. In March 2023, X-energy announced a Joint Development

Agreement (JDA) with Dow to demonstrate the first grid-scale advanced nuclear reactor for an industrial site in North America. Under the JDA, Dow will become a subawardee under the DOE's Advanced Reactor Demonstration Program and will install a Xe-100 reactor plant at the Dow's Seadrift facility by the end of this decade. Before this announcement, X-energy's original ARDP partner was Energy Northwest. Since the X-energy announcement with Dow, Energy Northwest has publicly announced a JDA with X-energy to deploy HTGRs in Washington state but are no longer part of DOE ARDP.

Separately, the ARDP award also funds building a commercial TRISO fuel manufacturing facility. In April 2022, X-energy announced that their TRISO-X Fuel Fabrication Facility will be constructed in Oak Ridge, TN and submitted an application to build the new facility. X-energy is also currently in the VDR Phase 2 licensing process and has signed an MOU with OPG to potentially deploy Xe-100s in Canada.

Introduction

Nuclear Expands
its Family Tree

○ Water Cooled Reactors

● Non-Water-Cooled
Advanced Reactor
Technology

○ Salt- and Sodium-
Cooled Reactors

○ High Temperature
Gas Cooled Reactors

○ Gas-Cooled
Fast Reactors

○ Micro-Reactors

Advanced Reactor
Demonstration Program
(ARDP)

Glossary

Non-Water-Cooled Advanced Reactor Technology GAS-COOLED FAST REACTORS

General Atomics



FMR: The company is designing a 44-megawatt electric Fast Modular Reactor (FMR) with Framatome and other organizations. The reactor is cooled with helium, which is routed directly to a turbine, so there is no steam generator and an overall high efficiency of 42% (as compared to the 33% efficiency of a light-water nuclear power steam cycle). This means that for every three units of heat produced in today's reactors, the plant produces one unit of electricity, but for a gas-cooled reactor, just over two units of heat will produce one unit of electricity. Reactors that make steam usually need cooling water to condense the steam back to water for re-heating, but this reactor requires little water to operate.

And the direct use of helium to cool the core and spin the turbines, called a Brayton cycle, enables fast power-level changes, with up to a 20 percent per minute power ramping rate. Control of the reactor power and turbomachinery is automatic, which keeps the reactor at a constant temperature, a benefit because frequent temperature changes can damage metal components.

With the help of a \$24.8 million grant from the Advanced Reactor Demonstration Program, General Atomics has begun a three-year project to complete the conceptual design and verify details about fuel, safety and performance. The plan is to demonstrate the design as early as 2030, and have it ready for commercial use in the mid 2030s.

HIGH TEMPERATURE GAS COOLED REACTORS (HTGRs) AND GAS COOLED FAST REACTORS (GFRs)

	Xe-100™ X-energy	Fast Modular Reactor™ General Atomics	Energy Multiplier Module™ General Atomics
FUNCTION	Flexible Electricity, Hydrogen Production, Industrial Processes	Flexible Electricity, Hydrogen Production, Industrial Processes	Flexible Electricity, Hydrogen Production, Industrial Processes
NEUTRON SPECTRUM	Thermal	Fast	Fast
MODERATOR	Graphite	None (Fast)	None (Fast)
HEAT TRANSFER MECHANISM	Helium Gas	Helium Gas	Helium Gas
OUTLET TEMP	750 °C	800 °C	850 °C
FUEL			
Enrichment	HALEU	HALEU	HALEU
Fuel Form	TRISO	UO ₂ in silicon carbide	Uranium Carbide
Refueling Period/Method	Online	180 months	360 months
POWER OUTPUT			
Classification	HTGR-SMR	GFR-SMR	GFR-SMR
Base Model Output (MWe or MWt)	80 MWe	44 MWe	265 MWe
Plant Scalability Output (MWe)	320 MWe (x4)	≥ 1 (≥ 44 MWe)	1060 MWe (x4)
REGULATORY PROGRESS			
Government Support	DOE ARDP Demonstration Award winner (up to \$1.25 billion)	DOE ARDP ARC-20 Award winner (\$31.1M)	
NRC Status	Construction permit readiness assessment in Q4 2023 with submission in Q1 2024.	Preapplication engagement	Preapplication engagement
CNSC Status	VDR Phase 1 and 2 in progress, completion expected in Q3 2023.	None	None
Expected Deployment:	ARDP (USA) Project Demonstration: 2029	Mid-2030s	Not publicly available

Non-Water-Cooled Advanced Reactor Technology MICRO-REACTORS

Micro-Reactors: This term “micro” is a description of size, not technology (see figure on the right). Micro-reactors are reactors that are a few percent (or less) of the size of the full-sized models now operating, producing electricity in the range of kilowatts to tens of megawatts. (And since they may be independent of the grid, their power output will have to vary according to demand in the very small area they serve.) Some are “mobile,” meaning that they can be shipped to the point of installation (by truck, cargo plane or helicopter), operated for days or weeks, then shut down and moved to another location, resuming production within days, if necessary. Some designs will incorporate the use of HALEU.

Micro reactors are well suited for use in remote settlements or mining operations that are not on the electric grid and now rely on diesel, which is expensive and sometimes difficult to ship in. Displacing diesel with zero-carbon nuclear energy avoids more carbon emissions than displacing natural gas with zero carbon energy. Micro-reactors will also have the capability to use their waste heat to serve local heating needs.

Another potential use is as backup power for critical installations, such as military posts, other government facilities, data centers, and hospitals that are on the power grid. Many of the locations that could use them need both electricity and steam, and the reactors can supply both, to a user on the grid, or to a micro-grid.

MICROREACTORS
SMALL REACTORS, BIG POTENTIAL

What are microreactors?
Microreactors are simple and compact reactors capable of producing **1-20 MEGAWATTS** of thermal energy used directly as heat or converted to electric power.

U.S. developers are currently focused on gas and heat pipe-cooled designs that could arrive in the next 10-15 years.

Microreactors have 3 main features:

- FACTORY-FABRICATED**
- TRANSPORTABLE**
- SELF-ADJUSTING**

What are the benefits of microreactors?

- SMALL & PORTABLE**
Fits on the back of a semi-truck and can be deployed to remote locations and military bases for reliable heat and power.
- SIMPLE DESIGN**
Fail-safe and self-adjusting designs that require fewer components, maintenance and operators.
- QUICK ON-SITE INSTALLATION**
Can be connected and generating power within months of arriving on-site. Some, possibly within weeks.

LEARN MORE: energy.gov/ne U.S. DEPARTMENT OF ENERGY Office of NUCLEAR ENERGY

Non-Water-Cooled Advanced Reactor Technology MICRO-REACTORS

EXAMPLES OF MICRO-REACTORS UNDER DEVELOPMENT

Oklo



Aurora: The Oklo Aurora Powerhouse is intended to run for 10-20 years on a single core of high assay low-enriched uranium in metal form. In 2019, the Department of Energy awarded Oklo a Site Use Permit to build their Aurora Powerhouse at Idaho National Laboratory and access to recovered spent nuclear fuel from the lab for use in its reactor. The company was the first microreactor to apply to the NRC for a combined license in March 2020. The application is currently pending resubmittal. DOE ARPA-e also has selected Oklo for three awards for developing waste-to-energy fuel recycling in collaboration with

several national laboratories. Each project differs and interacts with Oklo's goal of making nuclear fuel recycling a reality. In May 2023, Oklo announced that they will be siting two new 15MWe Aurora reactors in Southern Ohio around the Portsmouth Gaseous Diffusion Plant south of Piketon, Ohio. The Aurora Powerhouse at the INL site and the second and third reactors in Ohio will incorporate fast neutron spectrum and will not use heat pipes, like their 1.5 MWe design was originally expected to. In July 2023, Oklo announced that they would be going public.

Non-Water-Cooled Advanced Reactor Technology MICRO-REACTORS

Ultra Safe Nuclear Corporation



MMR Energy System: The Micro Modular Reactor (MMR®) Energy System is a graphite-moderated, helium-cooled reactor that would provide 5 megawatts of electricity, or 15 megawatts of heat, over a 20 year operation period. The core has proprietary ceramic micro-encapsulated fuel (FCM®) in graphite blocks. It is designed for process heat or electricity. In June 2021, the University of Illinois at Urbana-Champaign (UIUC), in collaboration with USNC, submitted a letter of intent to the NRC to apply for a test and research reactor license. The project would provide clean, high temperature steam for the university's campus central heating system. In December 2021, UIUC submitted their Regulatory Engagement Plan to the NRC.

Separately, in 2019 Global First Power, a collaboration between Ontario Power Generation and USNC, announced that it would be seeking to demonstrate the MMR technology at the Chalk River site in Ontario, Canada. The application for a Licence to Prepare Site has been filed with the CNSC. In May 2021, Ultra Safe Nuclear Corporation passed through the Canadian Nuclear Safety Commission's preliminary VDR stage and entered the formal licensing review process. Additionally, in March 2022, USNC announced they would be siting their new Pilot Fuel Manufacturing (PFM) operation in Oak Ridge, TN and have begun producing FCM® fuel. The company is also exploring the use of its technology for space propulsion.

Non-Water-Cooled Advanced Reactor Technology MICRO-REACTORS

BWXT



BANR: In December 2020, BWX Technologies, Inc. was selected by the U.S. Department of Energy (DOE) to lead a microreactor development project. The company's BANR (BWXT Advanced Nuclear Reactor) program will pursue the development of a microreactor with the design focused on advanced TRISO fuel particles to achieve higher uranium loading and improved fuel utilization. TRISO refers to a specific design of uranium nuclear reactor fuel that has many operational and safety benefits. The company's BANR (BWXT Advanced Nuclear Reactor) is a

microreactor using TRISO fuel and was selected to participate in the U.S. Department of Energy's (DOE) Advanced Reactor Demonstration Program (ARDP). BWXT is focusing on aggressive cost reductions for deploying this transportable microreactor through performance improvements and lower delivery costs. BWXT is on track to deliver the first round of BANR's TRISO fuel for testing at Idaho National Laboratory's Advanced Test Reactor in 2024.

Non-Water-Cooled Advanced Reactor Technology MICRO-REACTORS



Project Pele: In June 2022, the Department of Defense's (DOD) Strategic Capabilities Office (SCO) selected BWXT as the final candidate to demonstrate the construction and operation of a TRISO-fueled transportable microreactor prototype. Project Pele will be the first advanced nuclear microreactor in the United States. SCO has partnered with the U.S. Department of Energy to develop, prototype and demonstrate a transportable microreactor that can provide a resilient power source to the DoD for a variety of operational needs that have historically

relied on fossil fuel deliveries and extensive supply lines. Transportable microreactors deliver clean, zero-carbon energy where and when it is needed in a variety of austere conditions for not only the DoD, but also potential commercial applications for disaster response and recovery, power generation at remote locations, and deep decarbonization initiatives. The reactor will be completed and delivered to the Idaho National Lab site by 2025.

Non-Water-Cooled Advanced Reactor Technology MICRO-REACTORS



Xe-Mobile and XENITH: X-energy was one of two companies to compete for [Project Pele](#) but their design, the Xe-Mobile, ultimately did not win the contract from the DOD-SCO. While the configuration of the military-grade Xe-Mobile design is closely held, additional details of X-energy's next-generation Integrated Transportable High-Temperature (XENITH) microreactor are

forthcoming. In May 2023, X-energy was awarded a [US DOE grant](#) to complete a preliminary design of XENITH, a 20 MWth high temperature reactor powered by TRISO fuel.

Non-Water-Cooled Advanced Reactor Technology MICRO-REACTORS

Westinghouse



eVinci: The eVinci™ Micro Reactor uses TRISO fuel and is designed for transportability to reduce construction costs and eliminate the need for waste and spent fuel storage on site. The entire plant can be packaged in three standard shipping containers and can be placed into operation in less than 30 days. The system can produce up to 5 megawatts of electricity, and heat can be captured for many uses, including heating nearby homes and other buildings. Westinghouse has been awarded funding under multiple DOE Programs to support development. In January 2023, Westinghouse announced that

is had begun Phase 2 of the VDR process in Canada. In February 2023, Westinghouse announced it had filed a Notice of Intent to submit key licensing reports for the eVinci™ microreactor to the U.S. NRC and the Canadian Nuclear Safety Commission for joint review. The technology is expected to be commercially operational by the end of the decade. Westinghouse is also exploring the opportunity to deploy a university research reactor at Penn State university in College Park, PA.

Non-Water-Cooled Advanced Reactor Technology MICRO-REACTORS

Radiant

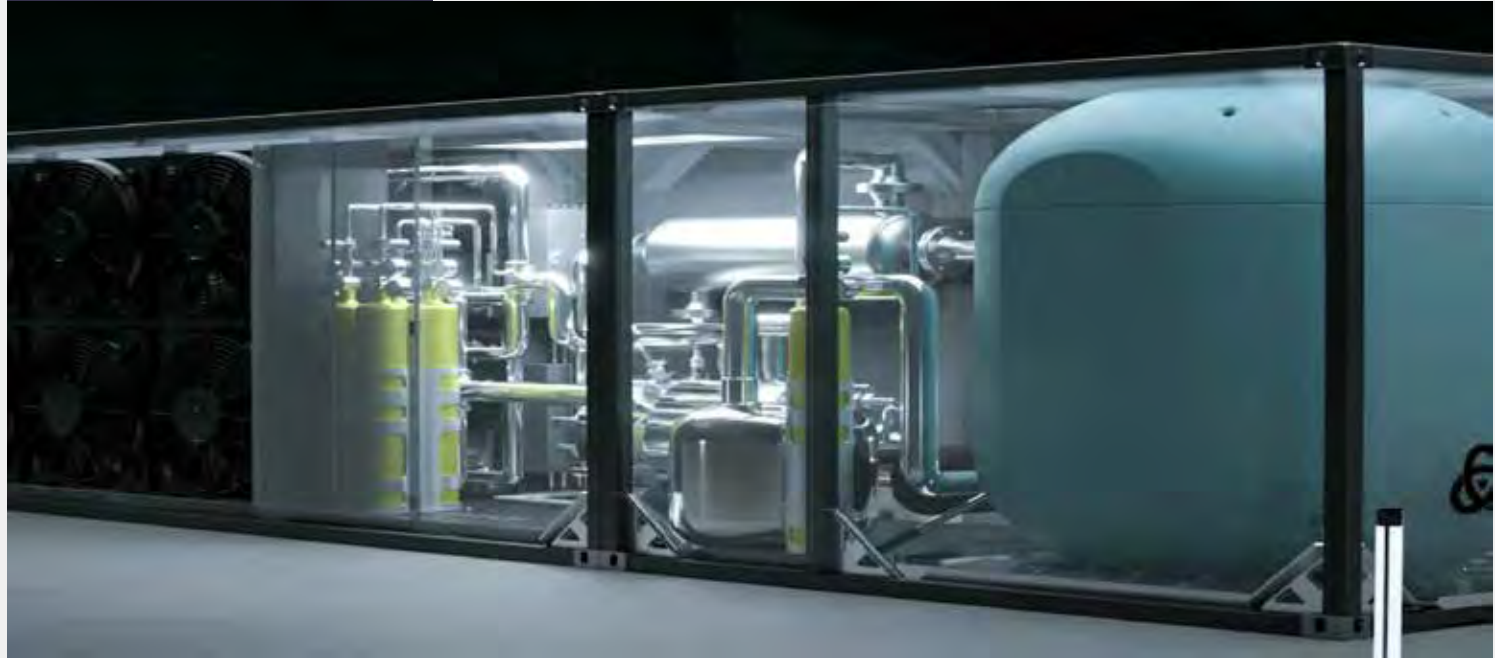

Kaleidos: Radiant is a company founded by ex-Space-X employees bringing knowledge from the aerospace industry to commercialize new nuclear technology. Their design is a transportable, high-temperature gas microreactor. The reactor will utilize TRISO fuel, and be cooled by a helium system. The reactor will be able to provide 1.2 MWe of clean electricity, or provide clean, high temperature steam. According to Radiant's website, the reactor is expected to be transportable by freight, ship, or plane, and can be operational as quickly as one hour after arrival, and requires no excavation. The reactor will be

able to operate up to five years at a time before needing to be refueled. One unit can be refueled multiple times with a maximum operational lifetime of 20 years. In January 2023, Radiant announced a partnership with Centrus to secure HALEU fuel. In March 2023, Radiant received an award from the U.S. Department of Defense to model and simulate microreactor integration scenarios at Hill Air Force Base. In April 2023, Radiant announced over USD \$40 million in private funding. The company is expected to demonstrate their technology by the late 2020s.

Non-Water-Cooled Advanced Reactor Technology MICRO-REACTORS AND THORIUM REACTORS

A variety of other developers around the world are working on designs and technologies. These include:

[Alphatech Research Corp](#)



[NuGen, LLC](#)



[Holosgen](#)



[Flibe Energy](#)



[Copenhagen Atomics](#)

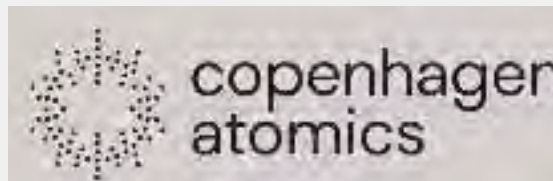

MICRO-REACTORS

	Aurora Powerhouse™ Oklo	Project Pele™ BWXT	eVinci™ Micro Reactor Westinghouse
FUNCTION	Microgrids, Extended Core Lifetimes, District Heating, Black start capability	Microgrids, Military Applications, Disaster Relief, Remote Communities	Microgrids, Emergency Response/ Transportability, Extended Core Lifetimes, District Heating, Black start capability
NEUTRON SPECTRUM	Fast	Not publicly available	Thermal
MODERATOR	None (Fast)	Not publicly available	Graphite
HEAT TRANSFER MECHANISM	Liquid Sodium	Not publicly available	Heat Pipes, Liquid Sodium
OUTLET TEMP	>500 °C	Not publicly available	>750 °C
FUEL			
Enrichment	HALEU (or recycled TRU)	HALEU	HALEU
Fuel Form	Metallic U-Zr	TRISO	TRISO
Refueling Period/Method	up to 240 months	Not publicly available but at least >36 months	48-60 months
POWER OUTPUT			
Classification	Micro	Micro	Micro
Base Model Output (MWe or MWt)	up to 15 MWe	1-5 MWe	1-5 MWe
REGULATORY PROGRESS			
Government Support	Idaho National Lab gave a Site Use Permit and will supply HALEU for fuel.	Project Pele: DOD-SCO Project Pele winner (\$300M)	DOD-SCO award (\$12M), DOE ARDP Risk Reduction award winner (\$9.3M), Canadian SIF award winner (CAD 27.2M)
NRC Status	Submitted application for combined operating license, March 2020. Currently pending resubmittal and new combined operating license applications.	Project Pele: N/A (DOE authorized) - NRC Observing	Preapplication engagement, Standard design certification application expected in FY23
CNSC Status	None	None	VDR Phase 2 Application under development
Expected Deployment	INL (USA) Project: 2026 SODI (USA) Project: Late 2020s	Project Pele (USA): 2025	Not publicly available

MICRO-REACTORS

	Micro Modular Reactor™ (MMR) Ultra Safe Nuclear Corp.	XENITH™; Xe-Mobile™ X-energy	Kaleidos™ Radiant	BWXT Advanced Nuclear Reactor (BANR) BWXT
FUNCTION	Microgrids, Space Reactors, Combined Power and Heat	Microgrids, Combined Power and Heat, Military Applications	Microgrids, Combined Power and Heat, Diesel Replacement,	Microgrids, Industrial Heat and Power, Remote Communities,
NEUTRON SPECTRUM	Thermal	Thermal; Thermal	Thermal	Thermal
MODERATOR	Graphite	Not publicly available; Not publicly available	Graphite	Graphite
HEAT TRANSFER MECHANISM	Helium Gas	Helium Gas; Helium Gas	Helium Gas	Helium Gas
OUTLET TEMP	630 °C	>750 °C; >750 °C	Unknown	> 800 °C
FUEL				
Enrichment	HALEU	HALEU; HALEU	HALEU	HALEU
Fuel Form	TRISO	TRISO; TRISO	TRISO	TRISO
Refueling Period/Method	up to 240 months	>36 months; >36 months	60 months, with a total 20-year product lifetime	> 60 months
POWER OUTPUT				
Classification	Micro	Micro; Micro	Micro	Micro
Base Model Output (MWe or MWt)	5 MWe	1-5 MWe; 1-5MWe	1.2 MWe	17-25 MWe
REGULATORY PROGRESS				
Government Support		Xe-Mobile: DOD-SCO Project Pele finalist (\$15M)	Unknown	BANR: DOE ARDP Risk Reduction Award winner (\$106.6M)
NRC Status	UIUC construction permit application expected in 2024	XENITH: Preapplication discussions	Unknown	BANR: QA Topical Report submitted to NRC
CNSC Status	VDR Phase 1 complete, VDR Phase 2 in progress License To Prepare Site Application submitted in 2021	VDR Phase 1 application in development	Unknown	None
Expected Deployment	UIUC (USA) Project: 2027 Chalk River (Canada) Project: 2027	XENITH Project: Not publicly available Xe-Mobile Project: Not publicly available	Kaleidos Project: Late 2020s	BANR: 2030s

Introduction

Nuclear Expands
its Family Tree

- Water Cooled Reactors
- Non-Water-Cooled Advanced Reactor Technology
 - Salt- and Sodium-Cooled Reactors
 - High Temperature Gas Cooled Reactors
 - Gas-Cooled Fast Reactors
 - Micro-Reactors

Advanced Reactor
Demonstration Program
(ARDP)

Glossary

Advanced Reactor Demonstration Program (ARDP)

Ten advanced designs are moving forward under the Energy Department’s Advanced Reactor Demonstration Program. The first awards were announced in December 2020.

Two projects were selected, with 50/50 matching funding by the government under the Demonstration category, for reactors that will be tested, licensed, built and operated within five to seven years under the Infrastructure Investment and Jobs Act (IIJA) that was signed into law in late 2021. These two projects are now fully funded, and have moved into the newly created Office of Clean Energy Demonstrations (OCED).

They are the Terrapower and GE-Hitachi Natrium project - a sodium fast reactor (SFR) that pumps energy into a heat storage system, and X-Energy’s high temperature gas reactor. Each project has been awarded \$80 million initially, and the program calls for a federal investment of \$4 billion over the next seven years.

Natrium Reactor
Sodium-cooled fast reactor
+ molten salt energy storage system
TERRAPOWER



Xe-100
High-temperature gas reactor
X-ENERGY

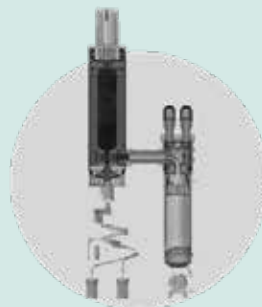

Five more projects were funded under a category called “risk reduction,” which will involve extensive work but will stop short of a full-scale working reactor. The goal is to resolve technical, operational and regulatory questions to prepare for a demonstration in the future. All of these programs are also subject to annual appropriations by the Congress.

Kairos Power will build the Hermes test reactor, to demonstrate its concept of a pebble bed fuel combined with molten fluoride salt. The Energy Department will pay \$303 million towards the \$629 million cost over 7 years.

KP-FHR
Fluoride salt-cooled
high-temperature reactor
KAIROS POWER



The eVinci™ Micro Reactor uses TRISO fuel and is designed for transportability to reduce construction costs and eliminate the need for waste and spent fuel storage on site. The DOE will pay \$7.4 million towards the \$9.3 million cost.

eVinci
Heat pipe-cooled micro-reactor
WESTINGHOUSE NUCLEAR



Advanced Reactor Demonstration Program (ARDP)

BWXT's Advanced Nuclear Reactor (BANR) is a transportable micro-reactor running on TRISO fuel, with efficient use of fuel, flexible output and inherent safety benefits. The DOE will pay \$85.3 million towards the \$106.6 million cost of a program to advance development of the reactor.

BWXT Advanced Nuclear Reactor (BANR)

High-temperature gas-cooled micro reactor

BWX TECHNOLOGIES



Holtec International will perform detailed design work on its SMR-160, an advanced light water design, and complete research and development work required for licensing. The DOE will pay \$116 million towards the \$147.5 million cost.

SMR-160

Advanced light-water small modular reactor

HOLTEC INTERNATIONAL



Southern Company and TerraPower will lead a project to design and build a Molten Chloride Fast Reactor. DOE will contribute \$136M towards the \$171M cost. Southern Company and TerraPower plan to construct and operate a 150 kW thermal test reactor at INL by 2025/2026.

Molten Chloride Fast Reactor

Molten salt reactor

SOUTHERN COMPANY

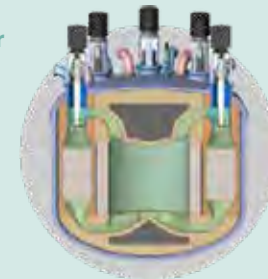

Advanced Reactor Demonstration Program (ARDP)

Three projects received funding for concept development:

ARC Clean Technology will produce a conceptual design of a seismically isolated sodium-cooled reactor, building on pre-conceptual work it's done for a 100 MW reactor facility. DOE will provide \$27.5 million of the \$34.4 million project cost.

Advanced Sodium-Cooled Reactor Facility

ARC CLEAN TECHNOLOGY

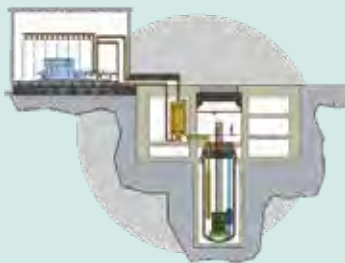

General Atomics will produce a conceptual design for a 50-megawatt fast modular reactor. The DOE will provide \$24.8 million of the \$31.1 million project cost.

Fast Modular Reactor

GENERAL ATOMICS



Boston Atomics (in partnership with the Massachusetts Institute of Technology) will produce a conceptual design of a horizontal Modular Integrated Gas-Cooled High Temperature Reactor to support commercialization activities. The DOE will provide \$3.9 million of the \$4.9 million project cost.

Horizontal Compact High-Temperature Gas Reactor

BOSTON ATOMICS AND
MASSACHUSETTS INSTITUTE
OF TECHNOLOGY



ARDP is not the Energy Department's only grant program for support of new reactors. The Department has also promised up to \$1.4 billion to the Carbon Free Power Project, the first nuclear project that will use the NuScale small modular reactor.

In addition, the Canadian federal government will invest \$45 million (in U.S. dollars) to help with development of a small modular reactor in New Brunswick, Moltex Energy's Stable Salt Reactor-Wasteburner, in addition to \$7 million from the U.S. DOE. And the provinces of New Brunswick, Ontario, Saskatchewan and Alberta have signed a memorandum of understanding to collaborate on SMR development.

Glossary

Actinides

A category of chemical elements (atoms) at the bottom of the periodic table from atomic number 89 to atomic number 103 that may be created in reactors. Some can be easily split in any reactor, but others can only be fissioned in a fast reactor. (As with all radioactive materials, some are highly radioactive but they do not exist for very long. Others are only slightly radioactive, but they remain that way for a long time.)

Boiling Water Reactors (BWRs)

These reactors use the heat from fission to boil water in the core. The steam is then run through a turbine, a propeller-like device that converts heat energy into mechanical energy, in this case a spinning shaft, which turns a generator. The term “BWR” differentiates these reactors from Pressurized Water Reactors, which heat water to hundreds of degrees Fahrenheit, but keep it from boiling by maintaining it under pressure. The hot water in a pressurized water reactor is run through a heat exchanger, a device with a cluster of tubes. The hot water runs inside the tubes, and back to the reactor for reheating; outside the tubes, another inventory of water is boiled, run through a turbine, condensed back into water and then sent back to the steam generator for reheating.

BTU

A standard measure of heat (not temperature, but quantity of heat). The letters stand for British Thermal Unit, and is the amount of heat needed to raise the temperature of one pound of water by one degree Fahrenheit. The measure is similar in nature to the calorie, which is the amount of heat needed to raise the temperature of one gram of water by one degree Celsius. The price of natural gas is usually quoted in millions of BTUs.

Chain Reaction

A process in which a series of atoms are split by neutrons and release additional neutrons that go on to split other atoms. In a nuclear power plant, the reaction is generally a steady-state process, wherein the neutron population in the reactor does not change, thus producing a self-sustaining series of reactions.

Coolant

A fluid (liquid or gas or molten metal or salt) that is used to transfer heat from the core so it can do useful work. Often the coolant’s heat is used to boil water into steam, which will be converted to mechanical energy in a turbine, and then to electricity in a generator. If the coolant is gas, it may be used to spin a turbine directly.

Enriched Uranium

In nature, 99.3 percent of uranium is in a form called “uranium-238,” which is difficult to split but can absorb a neutron (i.e., is “fertile”) and convert into a form of plutonium that is easy to split (“fissile.”) The other .07 percent is uranium-235, which is “fissile.” Light water reactors, the kind operated in the United States today, typically use a mixture of uranium that is about 5 percent uranium-235, called “enriched.” Some designs call for uranium at enrichments of up to 19.9 percent, which is the administrative limit for civil uranium enrichment.

Energy Grid Blackout

A failure of the high-voltage bulk power system, typically affecting hundreds of thousands or millions of customers, and lasting hours or days.

Fast Neutrons

High-energy neutrons that can split atoms that are not usually considered fissile.

Fast Reactor

A reactor in which the neutrons produced in a fission reaction are not slowed down by a moderator, like water or graphite. These high-energy neutrons can split a wider range of atoms as fuel.

Fissile Atom

Describes an atom that can be split by a **thermal neutron**, a low-energy neutron of the kind produced in today’s **light water reactors**.

Glossary

Fertile Atom

An atom that is difficult to split in a reactor, but that is prone to capturing neutrons released in a chain reaction, and can be converted into a fissile atom, one that is easy to split. U-238 is fertile, and when it absorbs a neutron, it converts into plutonium-239, which is fissile. Thorium is not fissile, but absorbs a neutron and becomes U-233.

Fission and Fusion

Heavy atoms at the bottom of the periodic table of the elements, mostly uranium and plutonium, can be split in a nuclear reactor, when a neutron, a particle from an atomic nucleus, hits another nucleus. As they fission, they release energy in the form of heat. Fissioning a nucleus also releases more neutrons, sustaining the **chain reaction** of fission. Nearly all of today's reactors use **uranium and plutonium**, but some advanced reactors could use other isotopes. Fusion also releases energy by disrupting an atomic nucleus, but it means squeezing two atoms together until they meld. Two types of hydrogen, deuterium and tritium, are most commonly used in artificial fusion reactions, but fusion of other isotopes is possible. Substantial research is still needed to develop the hardware that can squeeze the atoms together rapidly enough to produce and harness energy in a power plant. Another challenge is producing more energy than is consumed in creating the fusion.

FLiBe Molten Salt

A molten salt made out of Lithium-Fluoride and Beryllium-Fluoride that can simultaneously act as a coolant and a solvent for fissile (and fertile) fuel.

HALEU

By definition, HALEU is uranium fuel enriched between 5% uranium-235 and anything below 20%.

Heat Transfer Medium

A heat transfer fluid is a gas or liquid that absorbs heat from the reactor core and transports it so it can be used for power generation. In some designs this is ordinary water, heated in the core, and moved as steam to a turbine where it is converted to mechanical energy and then electricity. In other designs, the coolant carries heat from the core to a heat exchanger, where the heat is given off to another loop of coolant, thus creating an intermediate heat exchanger, and further isolating the core from the environment. In some cases the material that circulates between the core and a heat exchanger isn't water and can be inert gas, liquid metal, or molten salt.

Intermediate Heat Exchanger System

All reactor designs incorporate heat transfer between two fluids but some designs may require multiple heat exchanges through multiple coolant loops. In some advanced reactor systems, an intermediate heat exchanger system is needed between a primary and secondary loop to serve as a barrier between the primary and secondary coolant loops, which helps avoid radioactive contamination of plant systems. In these designs, the secondary loop will further transfer heat that will be ultimately used for power production or a secondary use. Most reactors have a heat transfer material (water, inert gas, liquid metal or liquid salt) that flows through the core, where it picks up heat (energy), and then flows to a heat exchanger, where it gives up that energy. The material then flows back to the core, for re-heating and repeats the process. In these designs, the heat transfer material that interacts with the core does not physically mix with the material to which it gives off its heat; typically, the gas, water or molten metal flows from the core through a non-nuclear device called a heat exchanger, a cluster of thin-walled metal tubes. The heat flows from the inside of the tubes to the outside, where it is picked up by another material, and pumped away for use. In pressurized water reactors in service today, the material outside the tubes is water, which is boiled into steam and is sent to spin a turbine, which is connected to a generator that makes electricity. That is called

Glossary

a secondary loop. But in some advanced reactor designs, there are three loops. The first runs from the reactor to a first heat exchanger; a second, intermediate loop, runs from a first heat exchanger to a second heat exchanger, and the third runs from a second heat exchanger to a turbine.

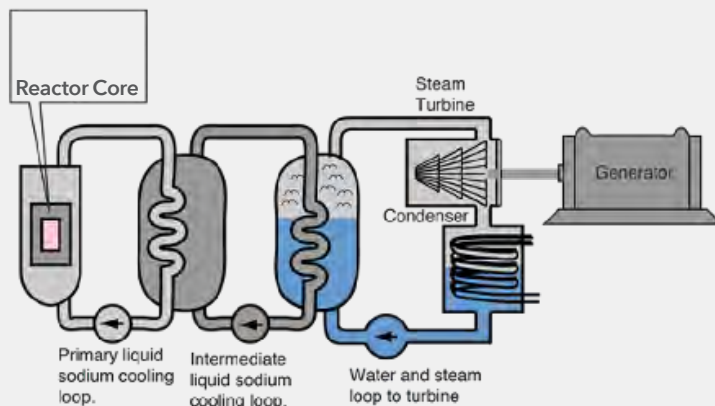

Illustration of an intermediate loop

Isotope

Variations on an element. An element is defined by the number of protons in its nucleus, but the number of neutrons can vary; uranium for example, is found in nature as uranium-238 and uranium-235, and a third version, uranium-233, can be produced in reactors. Fission products, or fragments of atoms of uranium or plutonium after they are split, come in a variety of isotopes, with varying levels of radioactivity and lifetimes.

Light Water

Ordinary H₂O. In a reactor, it is used as a moderator, to slow down the speed of the neutrons that sustain the chain reaction. The term is used to differentiate from **heavy water**, another potential moderator, that is used in Canadian-designed nuclear energy plants. Light water contains hydrogen atoms that consist of a proton and an electron. Heavy water atoms have a variant of hydrogen called deuterium, in which the hydrogen nucleus has an extra neutron. The significance in a reactor is that light water sometimes captures a neutron released in fission, preventing that neutron from causing another fission; heavy water is much less likely to capture another neutron. Heavy water occurs naturally and is chemically identical to light water.

Light-Water Reactors

Reactors that use ordinary H₂O as a **moderator/coolant**. See "Light water."

Liquid Sodium

Sodium is a metal that melts into a liquid at about 208 degrees Fahrenheit but does not boil until a temperature above 1,600 degrees Fahrenheit. It absorbs heat easily, and does not expand much as it is heated, due to its liquid temperature range, allowing high-temperature, low-pressure operation. These characteristics make it highly desirable as a heat transfer medium, to carry the heat of fission away from the core, to a steam generator where it can boil water into steam that can be used to turn a turbine, or for other uses.

Liquid Temperature Range

The temperatures between which a substance (in this case, a **heat transfer medium**) remains liquid. Materials that boil, like water, create very high pressures. A material that stays liquid at high temperatures is useful for high-temperature, low-pressure designs. Higher temperature heat can produce electricity more efficiently, and can substitute for high-carbon fuels in more kinds of industries. Low pressure means lower construction expenses.

Glossary

Loss of Coolant Accident (LOCA)

A malfunction in which the heat transfer medium of a reactor leaks away, or, in the case of water, more likely boils away. The fuel continues to generate high levels of heat for the first few hours after the reaction has stopped; it can overheat and the fuel can become damaged, potentially releasing radioactive fission products into the reactor vessel or the reactor building.

Moderator

A liquid or a solid used in a reactor to slow down neutrons as they are emitted in fission, to a speed most likely to cause another fission when the neutron collides with the nucleus of another atom of uranium-235. Reactors that do not use moderators are called “fast reactors,” and have higher-energy neutrons that can fission other, harder-to-split atoms.

Molten Salt

Salt heated until it melts into a liquid. As a coolant, it can reach very high temperatures at low pressures, a design advantage compared to water. In some designs, the fuel is dissolved in the salt, and in other designs, the fuel is a solid that will have its heat transferred away by the salt. A variety of salts can be used, including fluoride and chloride salts. Salt designs allow them to readily absorb fission products, a safety feature, and molten salt can ease the online refueling process.

Natural Uranium

Uranium commonly occurs in two forms, uranium-238, which has a total of 238 neutrons and protons in the nucleus, and uranium-235, which has a total of 235 protons and neutrons. In natural uranium, the mix is 99.3 percent uranium-238 and 0.7 percent uranium-235. The uranium-235 is easier to fission than uranium-238, and makes up most of the fuel of U.S. power reactors. However, before uranium is loaded into a power reactor, the mix is altered in an industrial process called enrichment, until the fuel is approximately 5 percent uranium-235. Some advanced designs call for mixes up to 19.9 percent. (Low-enriched uranium, which is for civil use, is defined as being enriched up to 20 percent.)

Neutron

A particle in a nucleus that is released when the nucleus is split in a reactor. The neutron may go on to split another nucleus, in a **chain reaction**, or may be absorbed by another nucleus of another atom, which will convert that atom into another element. One class of atoms is called “**fertile**” because it tends to absorb neutrons, and are thus converted to a different class, “**fissile**,” meaning atoms that are easy to split and thus are good reactor fuel.

Neutron Energy Spectrum

When atoms split, they emit neutrons, the sub-atomic particles that sustain the chain reaction at a range of energy levels that correspond to speed. Like traffic on a city street or a highway, the range of speeds can be described as fast, intermediate or slow. In a reactor, slow neutrons are referred to as “thermal.”

Neutron Spectrum

The mix of energy levels of neutrons that are released by fissioning an atom. Some neutrons are in the “**thermal**” spectrum, meaning that they are relatively slow and are likely to split atoms of uranium-235, or be absorbed by atoms of uranium-238. When uranium-238 absorbs a neutron, it is converted into reactor fuel. Other neutrons are “**fast**,” meaning that they have higher energy and can split many more types of atoms. Neutron energy level is a function of reactor design. Splitting an atom results in high-energy neutrons, but in reactors that have a moderator, some of that energy is given off to the **moderator**, converting fast neutrons into thermal neutrons.

On-line Refueling

Inserting fresh fuel and removing used fuel while the reactor is running. Current-generation light-water reactors are batch-loaded, usually once a year or once every 18 months, shutting down for several weeks for refueling and maintenance. CANDU reactors are refueled continuously.

Thermal reactor

A reactor with a **moderator**. The moderator slows down the neutrons emitted in fission, in contrast to a **fast reactor**, which is unmoderated.

Glossary

Passive Safety

A characteristic based on reliance on natural principles instead of mechanical systems to maintain safe operation. Examples include having a tank of emergency water above the reactor, so the water can flow by gravity instead of needing a pump. Some designs rely on cooling by conduction, in which excess heat flows through steel or water or surrounding rock, or through convection, the natural tendency of heat to rise. A related term sometimes used in the industry is “walk-away safe,” which means that no operator action is required to preserve safety, although the operators would not, of course, walk away.

Pebble Bed

fuel elements consisting of a fuel particle wrapped in concentric layers of silicon carbide and other heat-resistant materials. Pebble bed reactor designs use inert gas or molten sodium to carry the heat away for industrial use.

Pressurized Water Reactor (PWRs)

A reactor that uses ordinary water as the coolant and moderator, and often heats the water to more than 500 degrees Fahrenheit, but keeps it from boiling by maintaining it under pressure. The heated water flows through a heat exchanger and gives off its heat to a second circuit of water that is maintained under lower pressure; that water boils, and is run through a turbine to produce mechanical energy, which turns a generator to make electricity. Most U.S. commercial reactors are pressurized water reactors. This is one of the two types of commercial reactors used in the United States; the other is **Boiling Water Reactors**, in which water is boiled in the core and goes directly to the turbine. Boiling water reactors and pressurized water reactors are sometimes classified together as **Light-Water Reactors**.

Small Modular Reactor

A reactor with an output of 300 megawatts of electricity or less. These are built in factories and shipped to the point of installation in one piece or a small number of pieces, allowing for higher quality, lower cost, and shorter time because construction of non-nuclear components, including foundations, containment domes and other steel-and-concrete structures, can proceed in parallel with reactor fabrication. An SMR can be any type of technology. Some organizations have used the term to mean

different things; Canada calls any modern nuclear reactor under 300 MWe an SMR, but in the United States SMR may specifically refer to advanced light-water reactors under 300 MWe.

TRISO fuel

TRISO fuel stands for TRI-structural ISOtropic particle fuel which are particles of uranium or other fissile fuel, wrapped in silicon carbide or other materials, extremely heat-tolerant. These are the “pebbles” in “pebble-bed” reactors, although they can vary in size from ping-pong balls to tennis balls.

Uranium Utilization (“Burnup”)

One metric of nuclear plant performance is how much of the fissile uranium has actually been consumed at the point that the fuel is removed from the reactor. High burnup means efficient use of fuel. One benefit of fast reactors is that they can consume a higher fraction of the available fuel than light-water reactors do. (“Burn” is a term borrowed from the fossil industry, but is used here to denote fissioning, not burning.)

10 CFR Part 53

The Code of Federal Regulations (CFR) is divided into multiple sections; Title 10 includes the NRC’s rules. Part 53 is under development in an ongoing rulemaking process initiated by Congressional directive in the Nuclear Energy Innovation and Modernization Act. Part 53 is intended to simplify the licensing of advanced reactors by setting safety performance standards as opposed to prescriptive rules and letting applicants demonstrate how they achieve the safety standards. Part 53 may be better suited for advanced reactors than the existing Part 50 or Part 52, which are prescriptive-systems tailored to conventional light-water reactors. All operating commercial reactors were licensed under 10CFR Part 50, which is a historical two-step process involving a construction permit and an operating license as the plant approaches completion. In the 1990s, the Commission approved a second pathway, 10CFR Part 52, which allowed an applicant to receive a combined license for construction and operation, with optional steps such as a reactor vendor [applying for approval of a reactor design](#) or builders applying for a site permit.