



DOE Microreactor Program

Current Yttrium Hydride Research and Future Plans

Technology Maturation Panel

GAIN-NEI-EPRI Microreactor Program
Workshop
June 2-3, 2020

Erik Luther
Moderator Work Package Manager

High Temperature Moderator Overview

- Moderating material reduces fuel mass requirements in microreactors
- Yttrium hydride retains H at high temperatures for more efficient energy production
- The focus is to perform activities to qualify $\text{YH}_{1.X}$ for use as a moderator
 - Efforts follow the needs identified in the moderator development plan.
 - Research will advance knowledge and satisfy needs for developers with moderated cores.
- ATR irradiation for post irradiation properties
- NCERC integral test for reactivity
- Initial version of Advanced Moderator Handbook

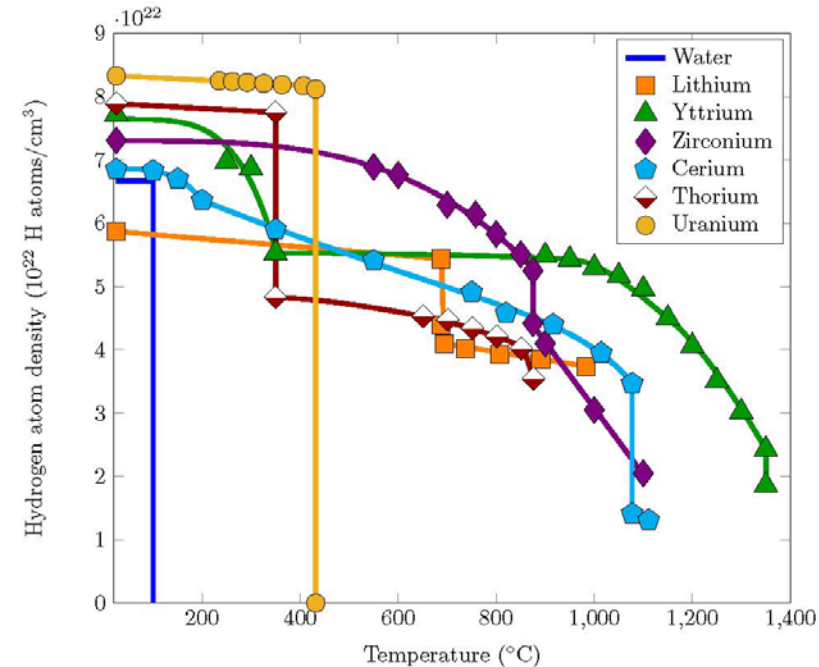

Fabrication of Yttrium Dihydride

- Direct (massive) hydriding
 - Yttrium hydride prepared by direct reaction of yttrium metal with hydrogen gas at 820°C +/-5°C in a Sievert's apparatus
 - 4.5 v% expansion from hydriding
 - Large yttrium castings may have defects
 - Expansion depends on microstructure
 - Post hydride machining
- Powder metallurgy
 - $YH_{1.x}$ powder crushed, milled and sieved
 - Green pellets pressed
 - Pellet sintered (patented method)
 - Oxidation
 - Complexity of process
- Scale up of fabrication capability
 - Sizes to 12"
 - Kilograms of material

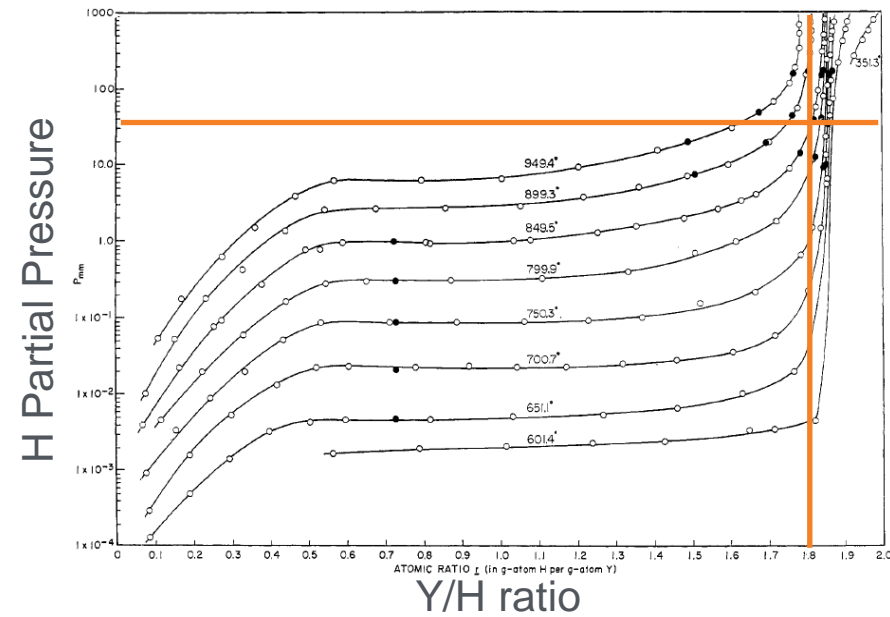

Direct hydrided

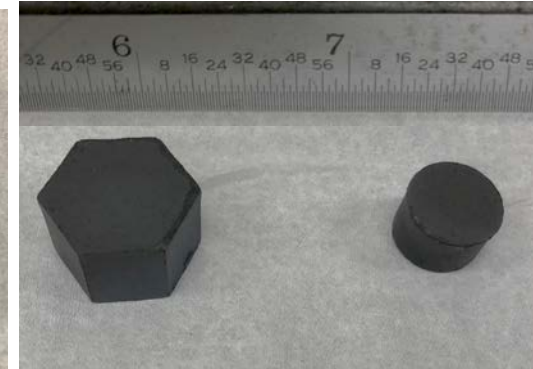

Powder Metallurgy

Thermophysical Properties Consistent with Literature

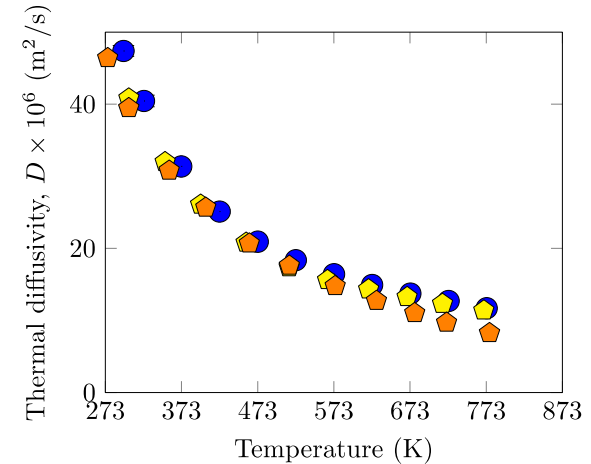
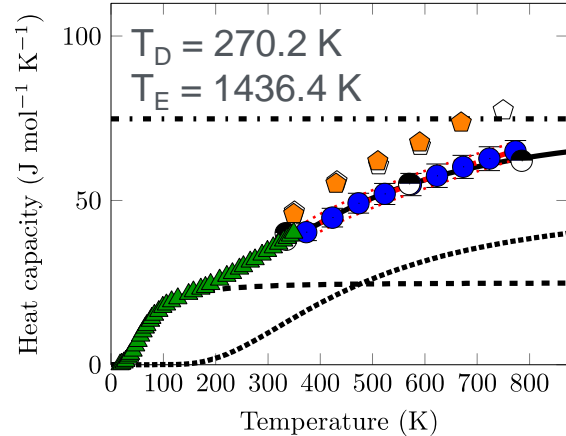
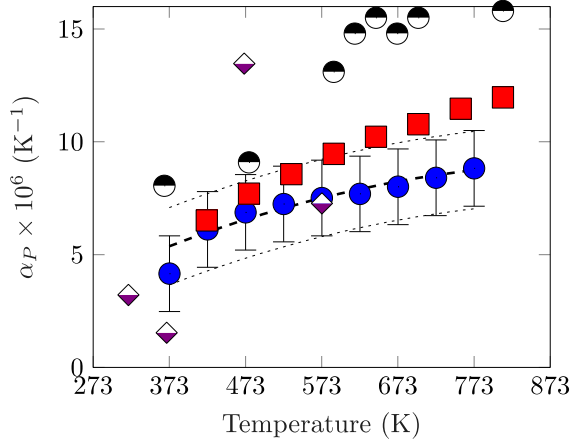

- YH_{1.90} (This study)
- YH_{1.94} (Lundin 1959)
- ◆ YH_{2-x} (Setoyama 2005)
- YH_{1.77} (Parker 1960)
- ▲ YH_{2.00} (Flotow 1962)
- ◻ YH_{2.00} (Ito 2005)
- ◼ YH_{1.86} (Ito 2005)
- ◼ YH_{1.90} (Ito 2005)

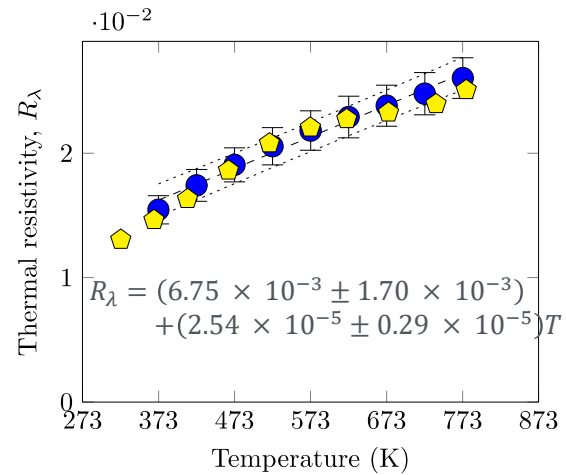
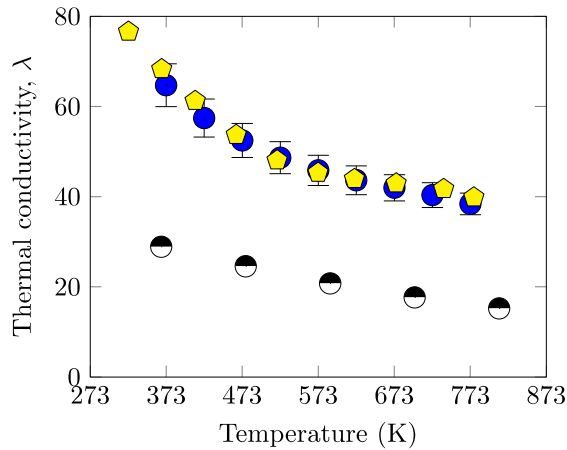

Shivprasad, et al. 2019

Measurements planned for YH

- Material Irradiation at Advanced Test Reactor (INL)
 - Focus on post irradiation thermophysical properties
 - Direct hydriding and powder metallurgy
 - 600°C, 700°C, 800°C
- Integral Critical Experiment at National Criticality Experiments Research Center (LANL)
 - Measure reactivity with central region heated
 - Various temperatures from 20°C to 330°C
 - Repeat with and without YH₂ in central region
 - Compare the change in reactivity

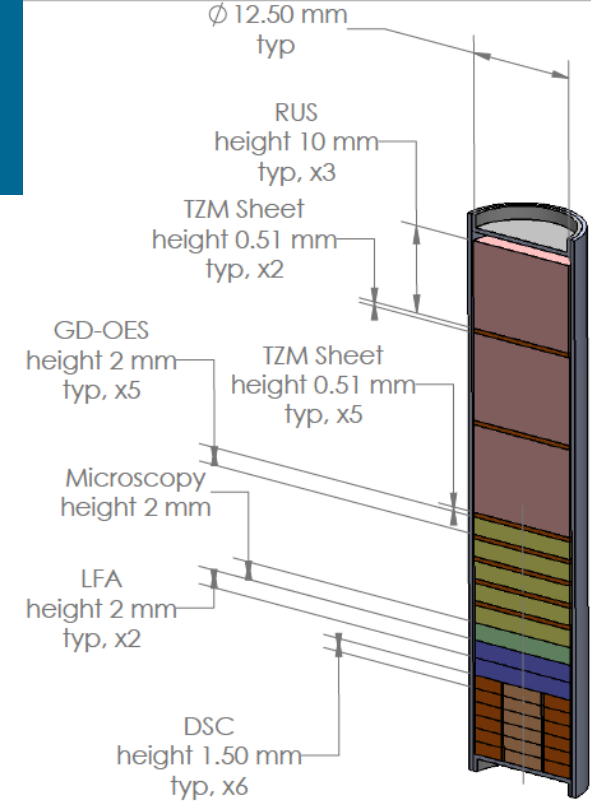

Components for ATR Irradiation



NCERC 6" Mo plate with YH₂

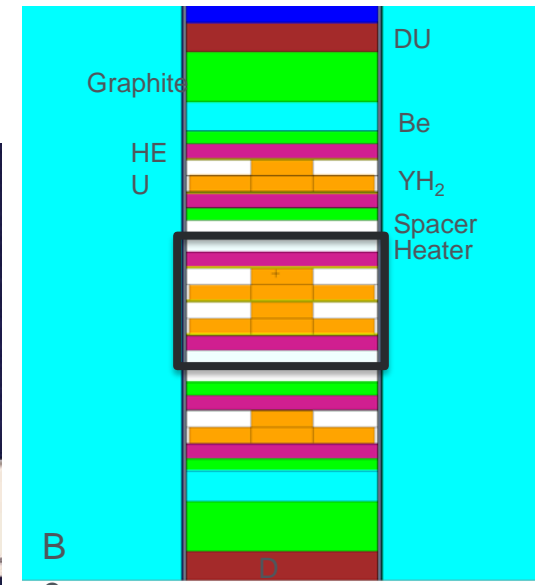

Current and Future R&D Activities

ATR Irradiation	Sample cans 8/2020	Insertion 2/2021	PIE 7/2021
NCERC Integral Critical Experiment	Sample cans 9/2020	Insertion 12/2020	
Establish Large-scale Fabrication Capability	Equipment 3/2020	Facilitization 9/2020	Installation 11/2020
Prepare Initial Version of Advanced Material Moderator Handbook	Draft 8/2020	Comments 9/2020	Issued 9/30/2020

- Investigate hydrogen redistribution under thermal gradients and irradiation
- Effects of irradiation vs stoichiometry of $\text{YH}_{1.x}$
- Effects of impurities and additives on hydrogen adsorption and desorption rates
- Effects of air exposure
- Cladding for maximum hydrogen retention and minimal cross contamination



Clean. **Reliable. Nuclear.**