



# MARVEL Technology Review:

## Utilization of MARVEL: Advanced Sensors and Controls Deployment

October 20, 2022 - 10:15

**Troy Unruh – INL Measurement Science Department / Advanced  
Sensors and Instrumentation**

# DOE Advanced Sensors and Instrumentation (ASI) program Mission, Vision, Goals, and Strategic R&D

## Mission:

*Develop advanced sensors, instrumentation, and controls (I&C) that address critical technology gaps for monitoring and controlling existing and advanced reactors and supporting fuel cycle development.*

## Vision:

*Program research will result in advanced sensors and I&C technologies that are ultimately qualified, validated, and ready to be adapted by the nuclear industry.*



## Program Goals:

- Identify technology gaps for sensors and instrumentation
- Increase technology maturity to expand applicability
- Demonstrate technologies in relevant conditions
- Support modeling simulation code validation
- Support fuels and materials qualification

## Strategy to achieve goal:

- Regular communication with stakeholders via conferences, surveys, and workshops
- Engage with University, National Laboratories, and Industry through Funding Opportunity Announcements
- Partner with University and National Laboratory reactors to facilitate prototypic deployment
- Compile and distribute collected experimental data for benchmarking code cases and studies
- Coordinate with congruent DOE-NE programs to supply instruments necessary for materials testing

The ASI program focuses on innovative research that directly supports and enables the sustainability of the current nuclear fleet, the development and deployment of next generation reactor designs, and advanced fuel-cycle technologies

# ASI technology maturation mechanisms

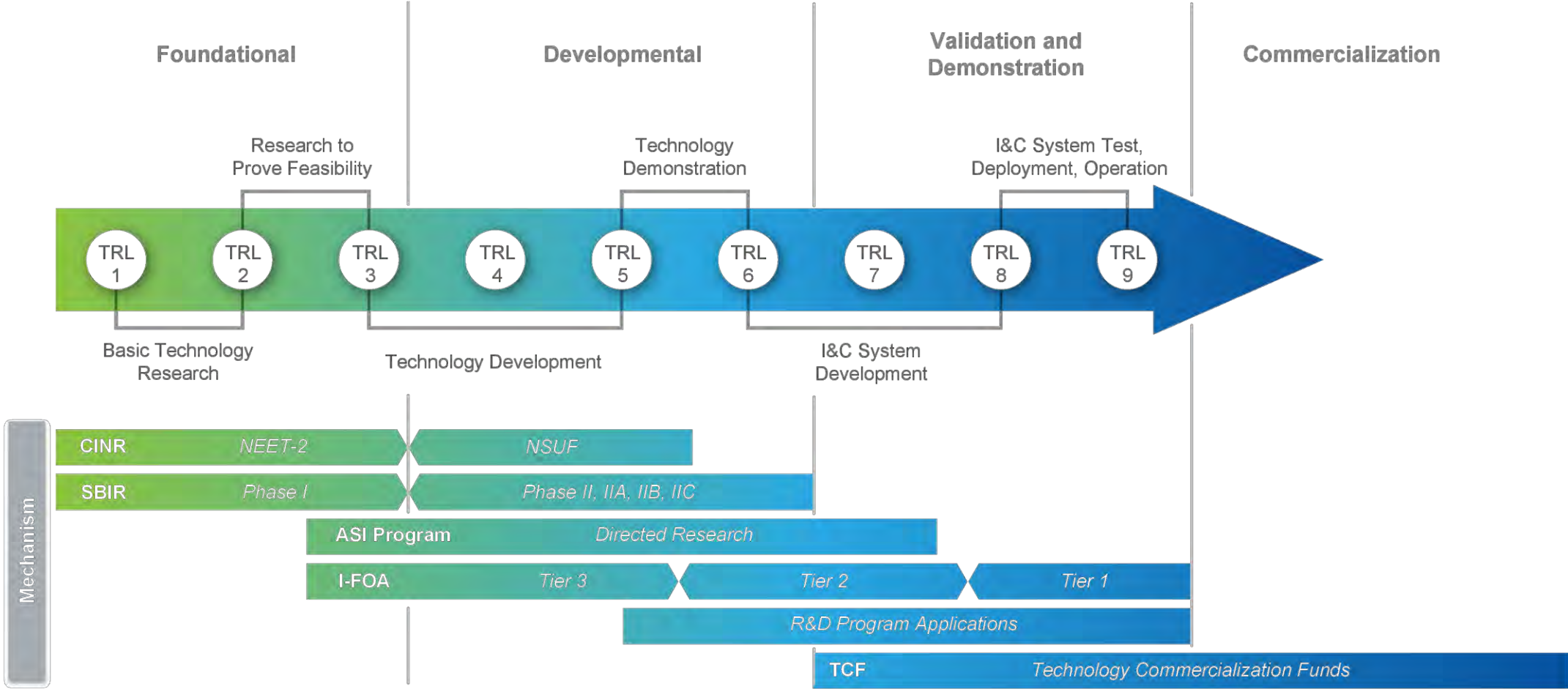



# Various ASI program achievements on sensors and sensor systems for irradiation experiments

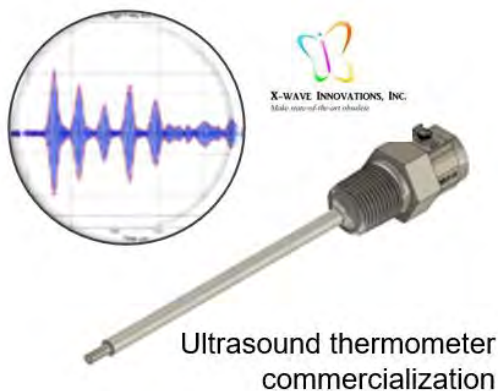

Ultrasound thermometer commercialization

Over the course of the last 11 years, the [ASI program](#) has fostered the development and commercialization of a wide range of technologies spanning the inception of novel sensing methods and the enhancement of instrumentation with a long history of commercial utilization. The program has funded over \$58 million in RD&D which supports the US Department of Energy and the US DOE Office of Nuclear energy missions. Sensors developed under the ASI program have been used to support other DOE-NE programs and have been commercialized for nuclear industry adoption.



High Temperature Irradiation Resistant (HTIR) thermocouples

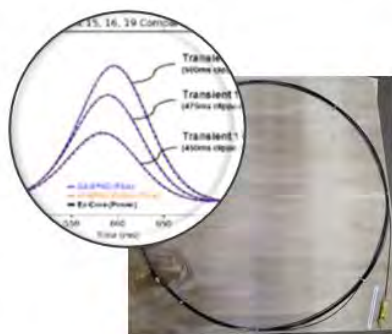

Self Powered Detectors and miniaturized Fission Chambers for local neutron flux measurement

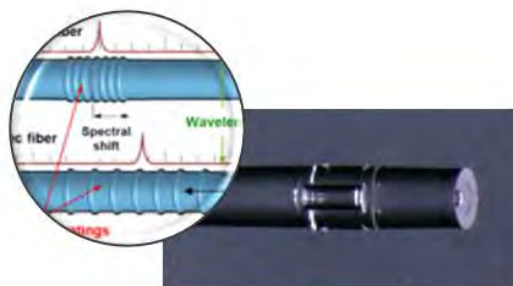

Fiber optic sensors for nuclear applications

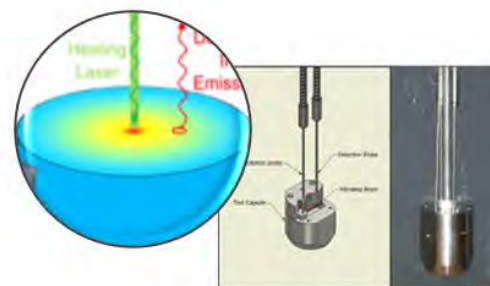

Real time measurement of fuel material properties in-core

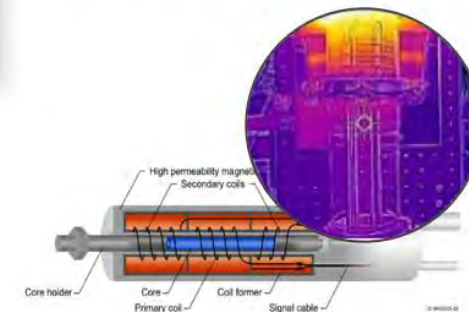

Linear Variable Differential Transformer (LVDT) for fission gas pressure measurement

# Sensor maturation using DOE testing infrastructure & **MARVEL?**

*Irradiation test requirements and technology maturity largely determine the appropriate facility for testing*

Low sensor TRL Technology  
Easier Access  
Lower Cost Tests  
Separate effects testing



**OSUR**  
University Reactor



**PULSTAR**  
University Reactor



**MITR**  
University Reactor

High sensor TRL Technology  
Limited Access  
Higher Costs, High Dose  
Controlled Prototypic Environment

DEVELOPMENT

PROTOTYPIC DEPLOYMENT

TREAT (INL)



MARVEL?



NRAD (INL)



ATR/HFIR (INL/ORNL)





# ASI Focus Activities and Near-Term Outcomes & **MARVEL?**

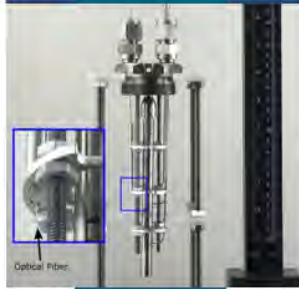

## Sensors for Irradiation Experiments

LVDT  
Passive Monitors  
Material Properties

Evaluate domestic supply chain for temperature tolerance *by 2023* and radiation resistance *by 2024*  
Benchmark SiC readout capabilities *by 2024*, incorporate advanced readout functionality for printed melt wires *by 2025*  
Finish development of thermal conductivity probe *by 2023*, perform test on U10Zr fuel specimen *by 2025*



## Sensors for Advanced Reactors

Self Powered Detectors (SPD)  
Fission Chambers  
Optical Fibers  
Acoustic Sensors  
Thermocouples  
Rad-hard electronics

Develop temp compensation *by 2024*, establish neutron spectrum unfolding tool *by 2026*  
Perform cross calibration with SPDs in heated irradiation *by mid-2025*  
Incorporate active compensation technique *by 2023*, extend temperature tolerance range of pressure sensor *by 2025*  
Benchmark new UT design *by 2025*, design optimization and benchtop testing of ultrasonic flow sensor *by 2026*  
Develop drift compensation model *by 2024* and perform/complete evaluation testing *by 2026*  
Fabricate radiation tolerant digitizer *by 2024*, with reliability demonstration *by 2027*



## Sensors Integration

Digital Twin  
Communication  
Advanced Controls

Develop model of adv. nuclear system *2023-2024*, and develop AI/ML tools with standard interfaces *by 2025*  
Qualify non-RF communication methods (i.e., fiber optics, induction, and acoustic) *2024-2025*  
Develop simulation platform for adv. digital control technology dev. *by 2024*, and initiate testing of platform *2024-2025*

AI/ML = Artificial Intelligence & Machine Learning  
SiC = Silicon Carbide

LVDT = Linear Variable Differential Transformer  
SPD = Self-Powered Detector

RF = Radio Frequency  
UT = Ultrasonic Thermometer

# Sensor testing

- MARVEL operational instrumentation
  - Observe trends
  - Noise analysis using independent loop comparisons
  - Analog/digital comparisons
    - Radiation hardened electronics



ORNL Front End Digitizer (FREND)

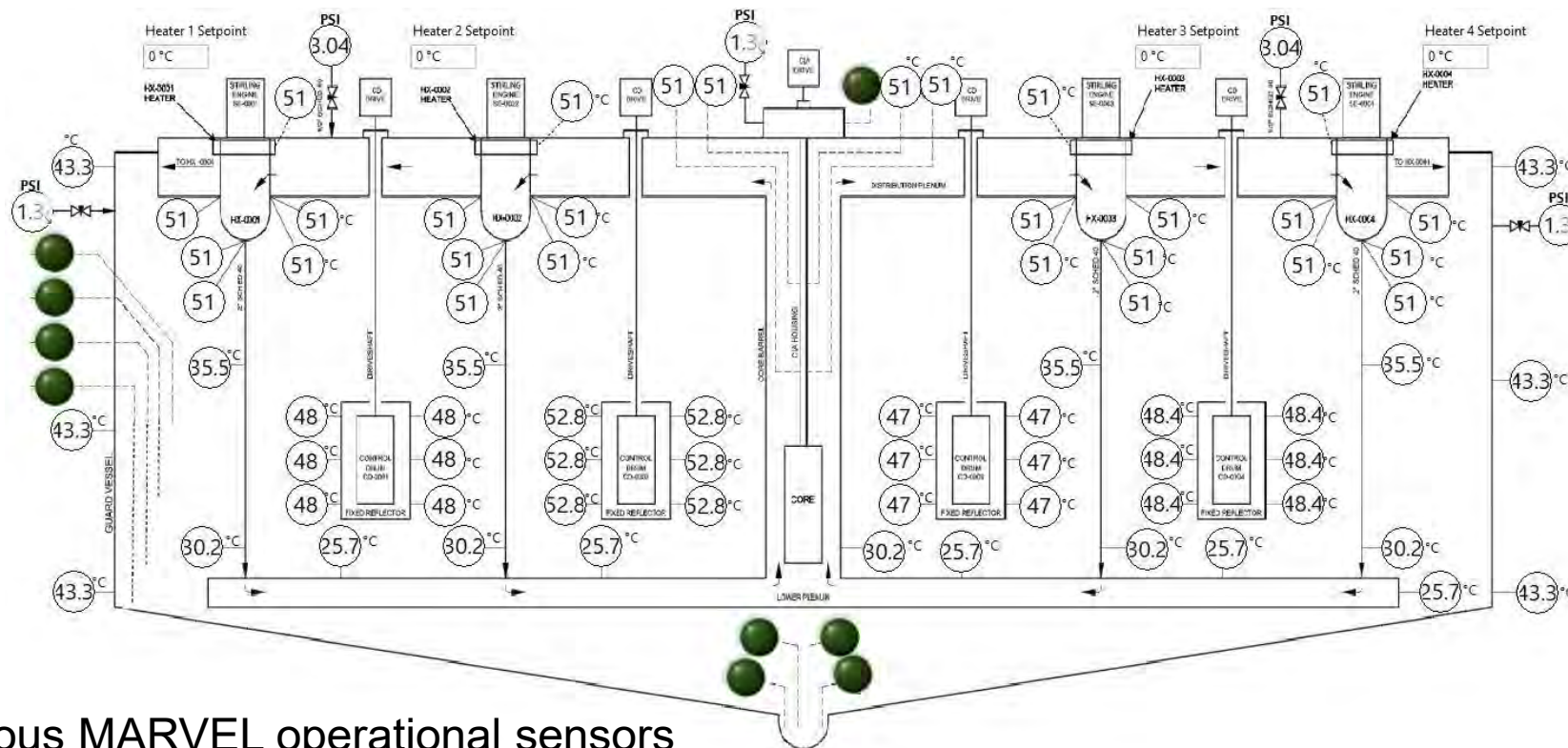

Various MARVEL operational sensors



# Additional sensor testing

- Neutron detector tubes accessible
  - Share space with neutron detectors
- Sealed Primary
  - Very limited inside guard vessel
  - “Replace” Central Insurance Absorber with instrumentation after operational history established

Neutron  
Detector Tubes

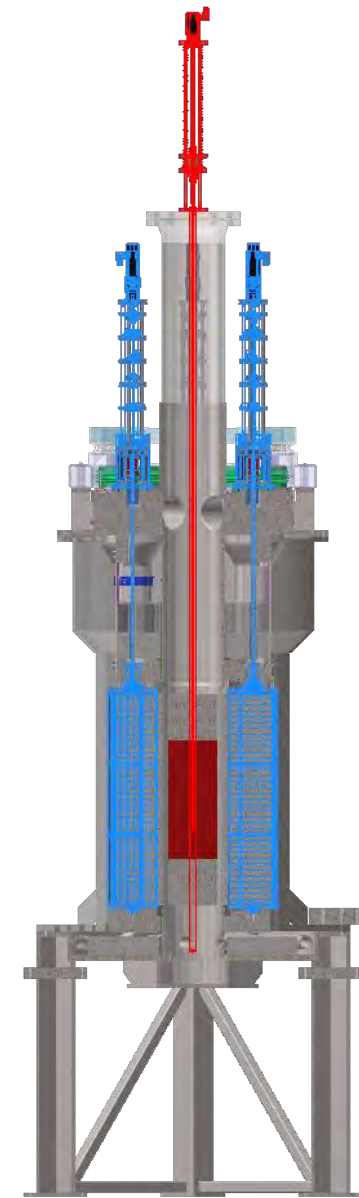
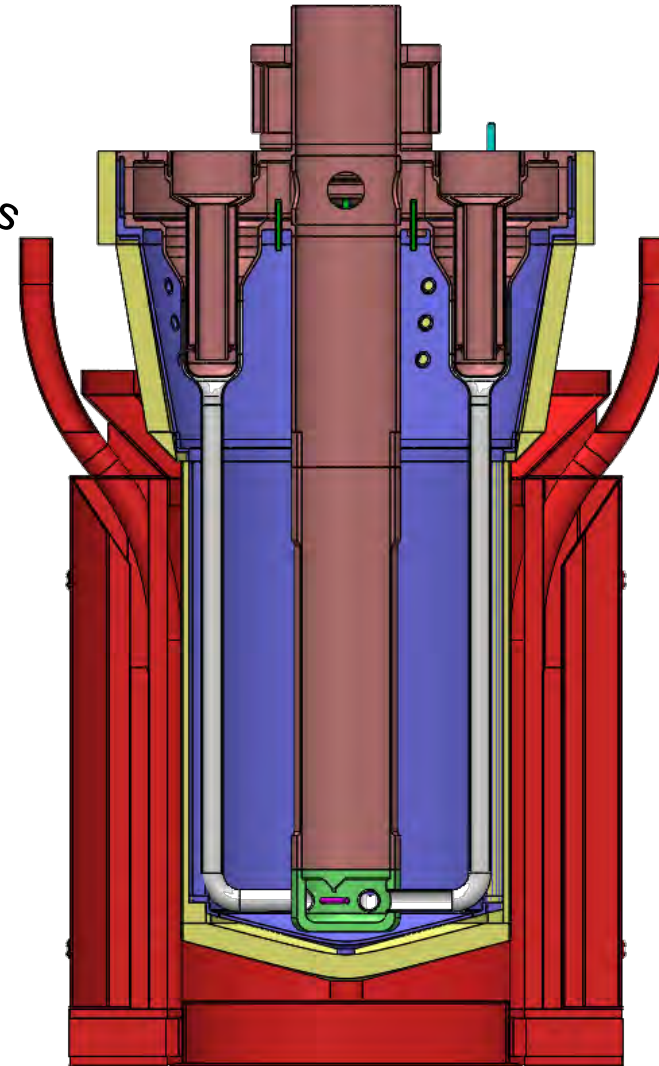

In place of CIA?



**MRP** Microreactor  
Program



# Beyond sensors, ASI has several related R&D areas that can benefit from MARVEL

Planned R&D activities address the technology gaps identified for each section of the program focus areas and draw from a broad range of disciplines to support the development of Instrumentation and Control solutions:

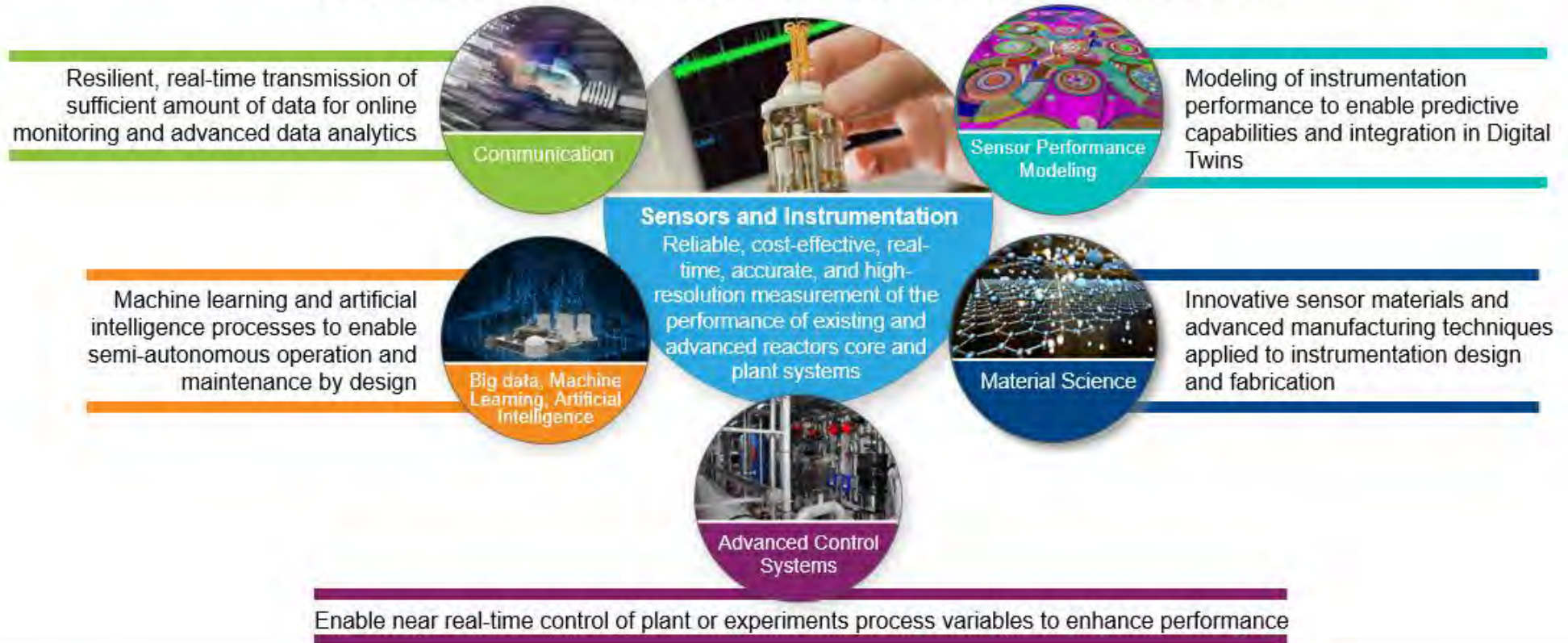

# ASI Focus Activities and Near-Term Outcomes & **MARVEL?**

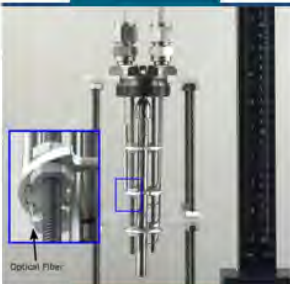

## Sensors for Irradiation Experiments

LVDT  
Passive Monitors  
Material Properties

Evaluate domestic supply chain for temperature tolerance *by 2023* and radiation resistance *by 2024*  
Benchmark SiC readout capabilities *by 2024*, incorporate advanced readout functionality for printed melt wires *by 2025*  
Finish development of thermal conductivity probe *by 2023*, perform test on U10Zr fuel specimen *by 2025*



## Sensors for Advanced Reactors

Self Powered Detectors (SPD)  
Fission Chambers  
Optical Fibers  
Acoustic Sensors  
Thermocouples  
Rad-hard electronics

Develop temp compensation *by 2024*, establish neutron spectrum unfolding tool *by 2026*  
Perform cross calibration with SPDs in heated irradiation *by mid-2025*  
Incorporate active compensation technique *by 2023*, extend temperature tolerance range of pressure sensor *by 2025*  
Benchmark new UT design *by 2025*, design optimization and benchtop testing of ultrasonic flow sensor *by 2026*  
Develop drift compensation model *by 2024* and perform/complete evaluation testing *by 2026*  
Fabricate radiation tolerant digitizer *by 2024*, with reliability demonstration *by 2027*



## Sensors Integration

Digital Twin  
Communication  
Advanced Controls

Develop model of adv. nuclear system *2023-2024*, and develop AI/ML tools with standard interfaces *by 2025*  
Qualify non-RF communication methods (i.e., fiber optics, induction, and acoustic) *2024-2025*  
Develop simulation platform for adv. digital control technology dev. *by 2024*, and initiate testing of platform *2024-2025*

AI/ML = Artificial Intelligence & Machine Learning  
SiC = Silicon Carbide

LVDT = Linear Variable Differential Transformer  
SPD = Self-Powered Detector

RF = Radio Frequency  
UT = Ultrasonic Thermometer



# ASI - Digital Technology for Advanced Reactors

## Integrating Digital Twins with Advanced Controls

- Digital Twins introduce significant opportunities in:
  - Enhanced anomaly detection
  - System state quantification and predictions
  - Improved AI/ML assisted control systems performance
- Communications enable seamless integration of new technologies, network architectures and security options
- Advanced controls support introduction of:
  - Performance-based control algorithms
  - Fault-tolerant controls for semi-autonomous plant operation
  - Artificial Intelligence and Machine Learning assisted solutions that improve plant performance utilizing operating history and physics-based models

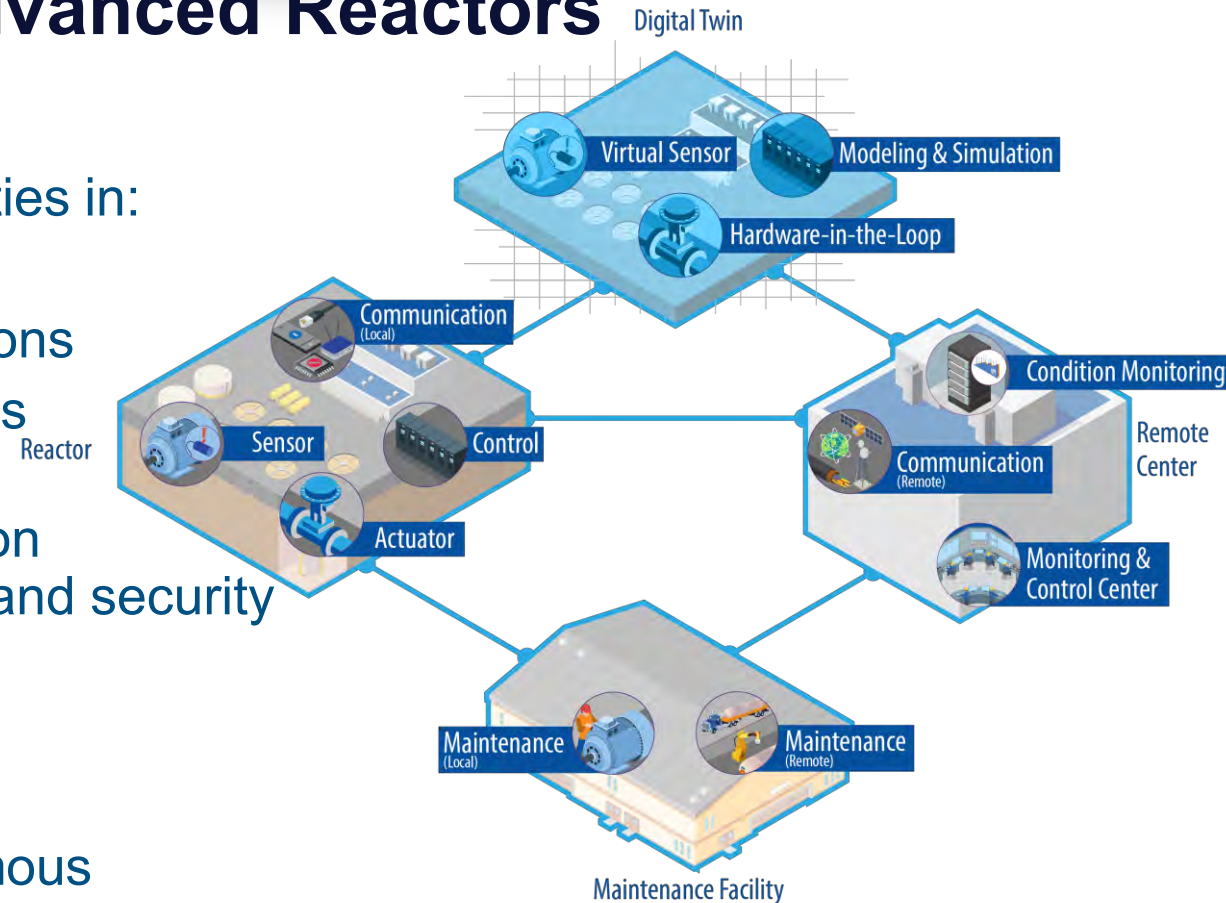

# ASI Digital Technology for Advanced Reactors, ANL/INL FY23

- Advanced Controls
  - Show how a Digital Twin (DT) can be used to design and inform a controller of the state of a process to switch to different operations modes and to demonstrate this use case using ANL's Parameter-Free Reasoning Operator for Automated Identification and Diagnosis (PRO-AID) at Mechanisms Engineering Test Loop (METL), a non-nuclear liquid sodium flow facility
  - Control method (high performance, digital, or AI/ML based) demonstration using existing models
    - MARVEL
    - METL
    - MAGNET
    - etc.

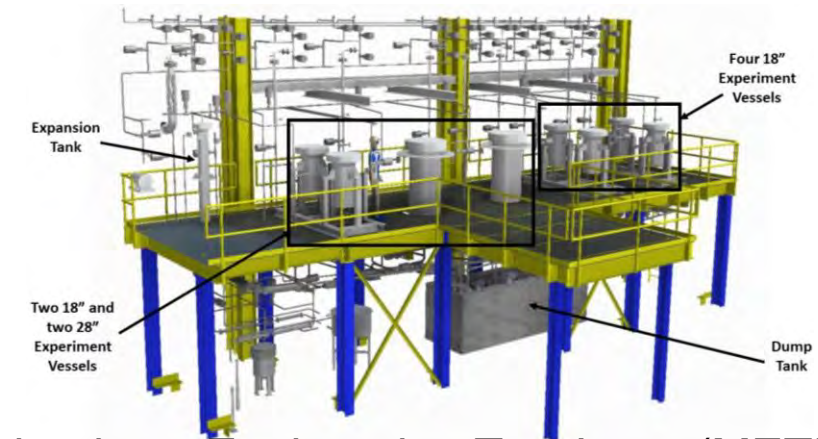
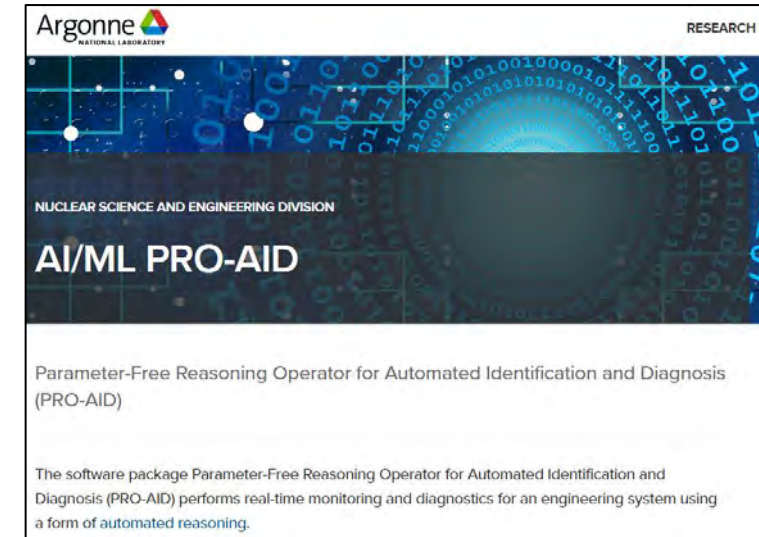

Mechanisms Engineering Test Loop (METL)





# MRP - Microreactor Automated Control System (MACS)



- MACS will use digital twins to automatically control microreactor hardware based on inputs from multiple sensors that could include measurements of reactor power, temperature, control element position, and heat rejection
- Development and demonstration activities will leverage existing designs for microreactors (initially MARVEL) to develop, test and demonstrate a high fidelity and robust MACS that can operate with minimal need for human-in-the-loop action
- Experimental demonstrations will focus on actuating microreactor-relevant hardware such as control element drive mechanisms, based on a simulated response from sensor inputs and the hardware in the loop simulator
- Operations training aid will allow operators to manipulate surrogate MARVEL control hardware prior to startup

Physical Digital Twin under construction

# Enable remote operations and/or monitoring of MACS/MARVEL

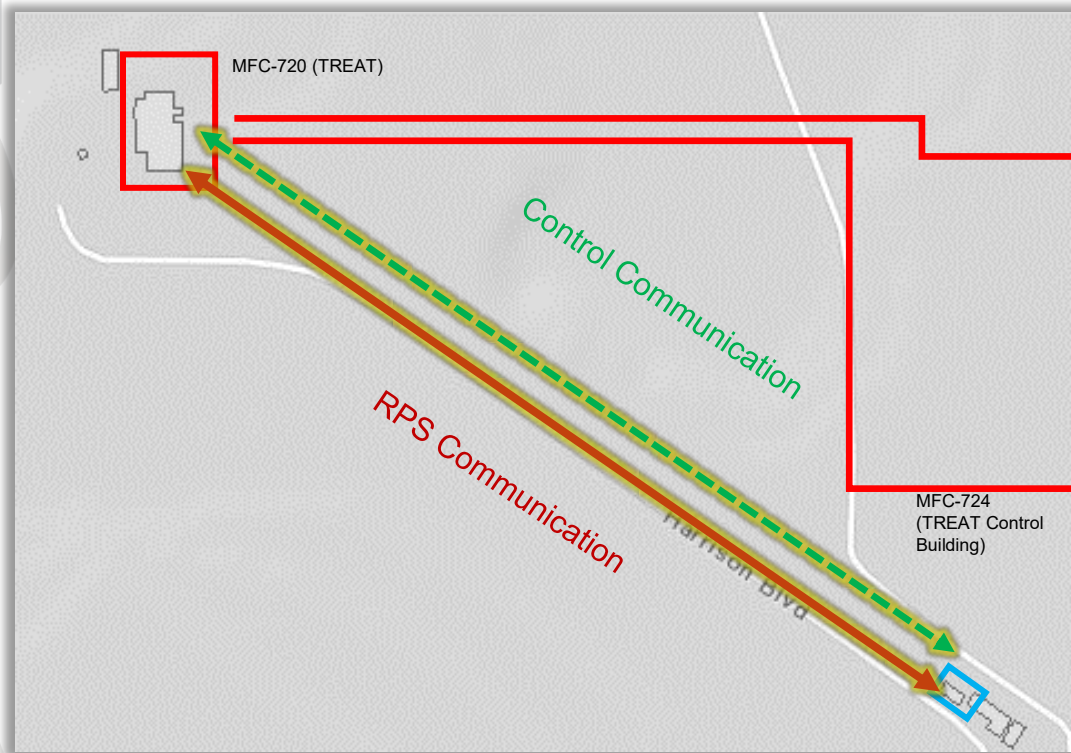

Human System Simulation Laboratory (HSSL)



ORNL campus

- Remote operation could be “bootstrapped” with in-person operator oversight and facility monitoring
- Verify secure operation and evaluate cybersecurity concerns



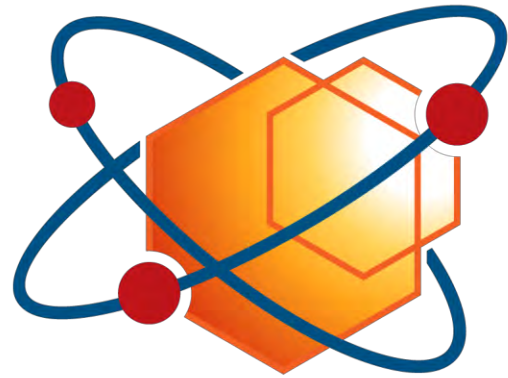

# MRRP Microreactor Program



**ASI**

**Advanced Sensors  
and Instrumentation**

<https://asi.inl.gov/#/> [www.linkedin.com/in/pcalderoni](http://www.linkedin.com/in/pcalderoni)

Troy Unruh

Nuclear Instrumentation Engineer (INL)

[Troy.Unruh@inl.gov](mailto:Troy.Unruh@inl.gov)

W (208)-526-6281

ORCID: 0000-0003-2417-9060

**LinkedIn**

